

# A5-MemoTS

M315 - Release 1.3.3.0



## INSTRUCTION HANDBOOK



**A+AUTOMATION**



For sales, service and spare parts

APM Mouldings 120-130 Bolinda Rd Campbellfield, VIC 3061  
Ph: 03 8301 9199 | Fax 03 9357 4077 | Email [apmoffice@chamton.com](mailto:apmoffice@chamton.com) | [www.apm-mouldings.com.au](http://www.apm-mouldings.com.au)

Australian Owned Family Company | Quality Moulding Manufacturers and Distributors

# Table of Contents

1. GENERAL INFORMATION.....	4
2. MACHINE DESCRIPTION .....	6
3. SAFETY .....	8
4. INSTALLATION.....	10
5. FUNCTIONING.....	18
6. QUICK GUIDE.....	26
7. BACKUP, TRANSFER, CODIFY .....	28
8. MAINTENANCE .....	30
9. DIAGNOSTIC .....	31
10.SPARE PARTS.....	33
11 MACHINE DEMOLITION .....	33
12.ATTACHMENTS .....	33



## 1. GENERAL INFORMATION

### 1.1 MANUFACTURER AND MACHINE IDENTIFICATION PLATE

The identification plate illustrated is affixed directly on to the machine. The plate contains all identification details and indications necessary for safe operation.

### 1.2 TECHNICAL SERVICE REQUEST PROCEDURES

For any requirement, please contact the Manufacturer's Customer Service.

For any request for technical service, list the data on the identification plate, the approximate number of hours the machinery has been used and the type of malfunction.



Tipo / Type:	<b>A5-MemoTS</b>
Anno di costruzione / Year of construction:	<b>2018</b>
Matricola / Serial Number:	
Peso / Weight:	<b>130 Kg / 298 lbs</b>
Alimentazione pneumatica / Pneumatic feed:	<b>5-7 BAR / 70-100 PSI</b>
Alimentazione elettrica / Power supply:	<b>110-220V - 50-60 Hz</b>

### 1.3 CERTIFICATION

The machine is produced in conformity to the pertinent European Community Norms in force at the moment of its introduction on the market.

### 1.4 WARRANTY

The replacement of defective parts is warranted (counting from the date written on the delivery bill) for a period of:

- Mechanical components - 24 months
- Pneumatic parts - 12 months
- Electrical and Electronic parts - 12 months

The driver blade is tested for about 1.000.000 working cycles.

The warrant does not include sending technical staff. The repair will be performed at A-Plus Automation's facility and the freight of shipment will be entirely charged to the Customer.

The warranty does not cover the damages caused by an inappropriate use of the machine or not corresponding to the instructions described in this handbook.

The warranty decays in case of unauthorized modifications or because of accidental damages or tampering performed by unqualified personnel.

The warranty also decays if you use wedges different from the original special steel A+ ones.

To take advantage of warranty services it is necessary, at the moment you receive your machine to completely fill out the warranty card and send back as soon as possible to A-Plus Automation.

The warranty will be valid after it is received & recorded at A-Plus Automation.

### 1.5 PRE-ARRANGEMENTS CHARGED TO THE CUSTOMER RESPONSIBILITY

It is the customer's duty, on times agreed with the producer, to execute what is indicated in the following documentation.

Things normally charged to the customer:

- Premises predisposition, included building works
- Pneumatic supply of compressed air (see at the paragraph 4.6.1)
- Machine power supply, observing the current norms of Country where the machine is installed (see at the paragraph 4.6.2)

### 1.6 PURPOSE OF THE MANUAL

The manual herein, part and parcel with the machinery, has been designed and built by the manufacturer with the purpose to supply the necessary information to the persons authorized to operate the machinery during its useful life. As well as adopting an appropriate utilization technique, the recipients of the information must read and strictly apply them.

This information is supplied by the manufacturer in its own language (Italian) and may be translated into other languages to satisfy statutory and/or sales needs.

A little time dedicated to the study of this information, will permit the user to avoid health and safety risks to personnel and economic loss.







The translation in the language of the country of use, supplied by the manufacturer, its representative or whoever brings the machine to such linguistic area, must be carried out from the “ORIGINAL INSTRUCTIONS” and must display the phrase “TRANSLATION OF THE ORIGINAL INSTRUCTIONS”.

In the event that the manual herein contains additional information concerning the fittings of the machinery, said information does not interfere with the reading of the manual.

Keep this manual for the entire duration of its useful life in a well known and easy to access place, available for reference any time the need should arise.

The manufacturer reserves the right to make modifications with no obligation to supply a prior notification.

## 1.7 SYMBOLS

SYMBOL	MEANINGS	
	<b>DANGER</b>	It indicates a danger with a mortal risk for the operator.
	<b>WARNING</b>	It indicates a warning or a note about key functions or useful information. Pay the maximum attention to the paragraph marked with this symbol.
	<b>OBSERVATION</b>	is requested to take a measurement data, to check a signal, etc.
	<b>INQUIRY</b>	The user is requested to check the proper positioning of any element of the machine, before operating a certain command.
	<b>EXAMINATION</b>	It's necessary to consult the handbook before effecting a certain operation.
	<b>ADJUSTMENT</b>	In specific particular cases of working and/or anomalies, it can be requested a certain mechanical adjustment and/or electrical setting.

## 2. MACHINE DESCRIPTION

### 2.1 GENERAL MACHINE DESCRIPTION

The frame assembling machine A5-MemoTS has been realized for the production of frames.

The machine is controlled by an electronic system able to execute the different working programs.

The machine can work only semi-automatically controlled and use a **special steel A+ wedges** to realize molding joints.

### 2.2 CONSTRUCTIVE CONFIGURATION

The main components constituting the machine are:

- Double Hydraulic hold down vertical clamp
- Frontal clamping device to have a correct clamping of the parts to be joined.
- Floor stand with Filter/regulator/lubricator
- Pneumatic opening of wedges magazine for a very quick reloading
- Claw-heads sizes 7, 10 and 15 mm.

### 2.3 AXIS

- X AXIS

Movement of horizontal. clamping

- Y AXIS

Movement of vertical clamping



### 2.4 AMBIENT CONDITIONS IN THE INSTALLATION AREA



The installation area must have adequate environmental conditions.

The installation area must meet the following requisites.

- Adequate lighting to European standards (recommended 250÷650 lux)
- Well ventilated rooms
- Adequate relative humidity and temperature. The permitted temperatures go from 5° to 40° C, with a humidity level not higher than 50% at 40° C or 90% at 20° C.
- The floor, as well as having an adequate load capacity for the machine weight, must be stable and levelled in order to guarantee a correct support.

## 2.5 VIBRATIONS

In standard conditions conformed to the indication of machine proper utilization the vibrations do not create dangerous conditions. The average quadratic weighed level, according to the acceleration frequency to which arms are exposed does not exceed 2,5 m/s<sup>2</sup>.

## 2.6 NOISE EMISSIONS

In standard working conditions the Machine noise power level is:

- Acoustic Continuous Equivalent weighed pressure A <70dB
- Acoustic Istantaneous weighed pressure level <130dB



**In case of any machine modification, the above mentioned levels could be changed.**

## 2.7 TECHNICAL DATA

- Frames Height min-max 8-100 mm /  $\frac{1}{4}$ " - 4"
- Frames Width min-max 10-180 mm /  $\frac{3}{8}$ " - 7"
- Wedges magazine capacity n. 200
- Standard wedges size 7, 10, 15 mm.
- Optional wedge size 3, 5, 12 mm.
- Pneumatic feed Bar 3-6 / Psi 40-80
- Air consumption 4,2 NI at 5 BAR  
0.14 cf<sup>3</sup> at 73 Psi
- Power supplying 220V 50 Hz / 110V 60 Hz
- Weight approx. 115 kg / 254 lbs
- Height of working bench 1000 mm / 40"
- Overall dimensions 880x680x140 mm  
35" x 27" x 56"
- Max programming capacity > 10.000
- Max Wedges inserting pos. 10
- Max Wedges stacking per pos. n. 9
- Serial linking support type RS 232

## 2.8 EQUIPMENT SUPPLIED

The equipment listed below are the standard ones:

### 2.8.1 Standard accessories

Once you have removed the packing, please check the presence of following accessories:

- N. 1 claw-head mm. 7
- N. 1 claw-head mm.10
- N. 1 claw-head mm.15
- N. 1 Allen Wrench 5 mm. for wedges claw-head replacement
- N. 4 adjustable feet
- N. 1 pressure gauge
- N. 1 quick connecting fitting
- N. 1 brass rod magnet to remove wedges
- N. 1 double hydraulic hold down

### 2.8.2 Optional accessories

This machine can be 'custom-made' to meet our users' requirements, by using additional accessories that can make frame assembling easier: e.g. special fences for peculiar moulding shapes, special clamps to ensure the mouldings are locked properly during wedge firing, and so on. You can have your local machine shop make these for you.

### 3. SAFETY

#### 3.1 GENERAL WARNINGS

- The manufacturer, during the design and manufacturing stages, has paid special attention to the aspects that might jeopardize the safety and health of the personnel that operates the machinery. As well as the compliance with current regulation on the matter, the manufacturer has adopted all the “rules of good craftsmanship”. The purpose of this information is to make the user aware to pay special attention in order to foresee any risk. There is no substitute for carefulness. Safety also lies in the hands of all operators that work on the machinery.
- Carefully read the instructions of the manual supplied with the machinery and the ones directly fitted on the machinery, especially the ones concerning safety. Time dedicated to the study of this manual will prevent unpleasant accidents; it is always too late to remember what should have been done when it has already happened.
- Pay attention to the meaning of the symbols of the plates fitted on the machinery; their shape and colour are important for safety purposes. Keep them readable and comply with their information.
- Do not tamper with, do not dodge, eliminate or bypass the safety devices installed on the machinery. The non-compliance with this requirement may cause serious risks for personnel’s safety and health.
- The personnel that carries out any type of operation during the entire useful life of the machinery must have specific technical competence, special skills and experience acquired and acknowledged in the specific sector. The lack of these requisites may jeopardize the safety and health of personnel.
- During operation only use the personal protection clothes and/or devices listed in the instructions supplied by the manufacturer and the ones provided for by current regulations on safety at work.
- During the normal use or for any intervention, keep the surrounding area in adequate condition, especially the one accessing the controls, in order to avoid jeopardizing the safety and health of personnel.
- The operator, as well as being adequately informed on the use of machinery, must possess skills and competence adequate to the type of working activity to perform.

The machine must only be used for the applications intended by the manufacturer. Only use the machinery for the purposes intended by the manufacturer. The employment of the machinery for improper uses may cause risks to the safety and the health of personnel and economic loss.

- Provide appropriate containers to stock the pieces you will be working with.
- Disconnect the main air supply and the power supply.
- Keep your foot off of the pedal during Machine maintenance

#### 3.2 SCHEDULED USE

The Machine is designed and built to execute junctions of frames.

The machine is projected for semi-automatic operation (under operator control).

#### 3.3 INADVISABLE USE

The machine can not be used for:

- For uses different from those listed in 3.2 paragraph
- In an explosive or aggressive atmosphere, where there is a high density of dust or oily substances suspended in the air
- In flammable atmosphere
- Outside in all weather severity
- With disconnected electromagnetic interlocks
- With electric bridges and/or mechanical instruments leaving out machine parts or functions
- For laths to be joined not suitable with machine characteristics.



### 3.4 DANGEROUS AREAS

- **Working area** Area of frames assembly.
- **Dangerous areas** include the movable parts and surrounding zones.



Figure 3.4.A - Working area and dangerous zones

### 3.5 PROTECTION DEVICES

The machine is equipped with adequate protections for persons exposed to the risks due to the transmission mobile elements, or movable organs taking part in working (driver blade, horizontal clamp, vertical clamp).

### 3.6 STOP FUNCTIONS

The machine stop functions are the following:

- Stop Category 0.
- Stop Category 1.

#### STOP CATEGORY 0

It is obtained by disconnecting the quick connect fitting from the main air supply from the feed system (uncontrolled stop). It is obtained by flipping the main switch located on the floor stand.

#### STOP CATEGORY 1

It is obtained by removing your foot off the pedal so that machine is unable to execute the cycle.

### 3.7 SAFE WORKING PROCEDURES

	<p><b>The machine is projected and realized to eliminate any risk connected with its use. The user is requested to achieve an adequate training. The local distributor can provide the training.</b></p>
---	--

The other risks related with working are:

- Finger crushing in the frontal and vertical clamp working area

It is necessary to carefully adhere to the following instructions:

- Keep the fingers away from frontal and vertical clamp working areas
- Disconnect the air pressure and the power supply during any maintenance interventions
- Keep the foot away from the pedal during machine maintenance.

### 3.8 DESCRIPTION OF SAFETY SIGNS

Some of these signals are applied on the machine. Their meaning is specified on their side.

Make sure that the plates are perfectly readable, otherwise replace them with new ones to be fitted correctly in place



Adhesive sign concerning the finger danger zone

## 4. INSTALLATION

### 4.1 HANDLING AND INSTALLATION

The personnel in charge of loading, unloading and moving the machinery must possess the skills and experience acquired and acknowledged in the specific sector, and must thoroughly know the lifting means to be employed. The machine has to be shipped in a safe way to avoid any damage to its parts.

- All the protections and guard devices must be properly closed and locked.
- According to the type of shipment, it is necessary to protect the machine from any jarring impact or stress

Figure 4.1A - machine handling indications

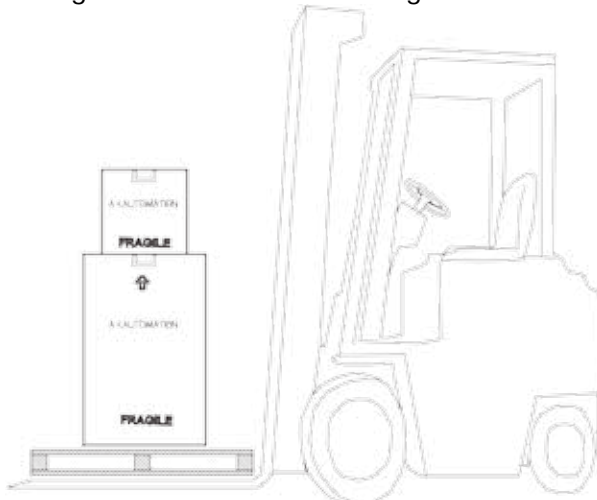

Machine's total weight: about 150 Kilos



**Lifting must be done by using a specific device.**

### 4.2 WAREHOUSING AND STORAGE PROCEDURES

- In order to avoid that the components cause dangers or are damaged, the storage area must be covered (preferably a closed area) and accessible only for authorised personnel.
- Avoid corrosive materials that could touch the machine
- Lubricate the parts which are not painted

### 4.3 UNPACKING

According to the installation requirements, the personnel authorised by the manufacturer will unpack the components in the most suitable way and will check their integrity.

Keep all packages (cases, pallets, etc.) for future use and dispose of the protection materials (nylon, polystyrene, etc.) according to the laws in force.

### 4.4 PRELIMINARY ARRANGEMENTS

To install the machine it is necessary to prepare a working area adequate to the machines dimensions, lifting devices chosen and length of mouldings to be worked.

### 4.5 MACHINE POSITIONING

Position the machine in its working area.

Screw in the provided levelors to the floor stand and level the machine by releasing or tightening the levelors.

## 4.6 PNEUMATIC CONNECTION

Unscrew the lubricator bowl out from the air filter lubricator."C"

Fill the bowl with lubricating oil up to the level mark.

Screw the "A" pressure gauge on the air filter

Screw the "B" quick disconnect fitting normally supplied or another suitable with the erising system. (See picture 3)

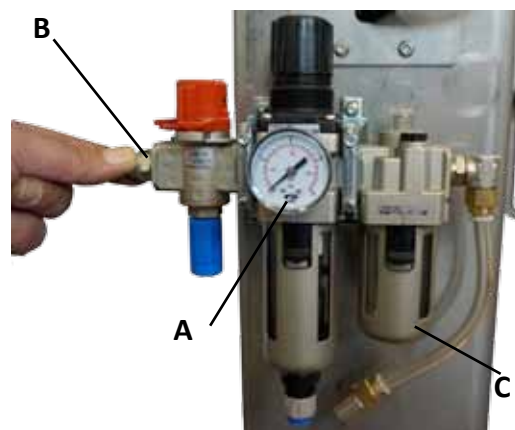

Picture 3

Connect the feed line to the fitting. (See picture 4)

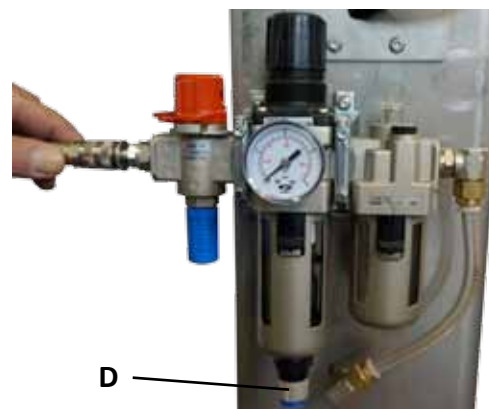

Picture 4



**In the lubricator it is advisable to use lubricant type CASTROL MAGNA GC 32 or an equivalent lubricant. Don't use generic lubricants !  
The use of non-suitable lubricants might damage the valves.**



**In order to eliminate the condensation in the filter press upwards on the "D" valve (see picture 4).**

To supply air to machine, turn the main air switch (see below pictures):



Air supply CLOSED



Air supply OPEN

## 4.7 ELECTRIC CONNECTION

### 4.7.1 Electric connection of the Panel PC

The Panel PC is equipped with

- two serial ports (COM1 and COM2),
- one LAN port one USB Port.



Connect the serial cable to the COM2 port and the power cable to the DC 24V connector as shown in the below image.



### 4.7.3 Electric power connection

Check the network Voltage: it must be the same of what indicated on machine cable (120 V).

Connect the power supplying cable to the plug positioned on the machines floor stand front mid side:

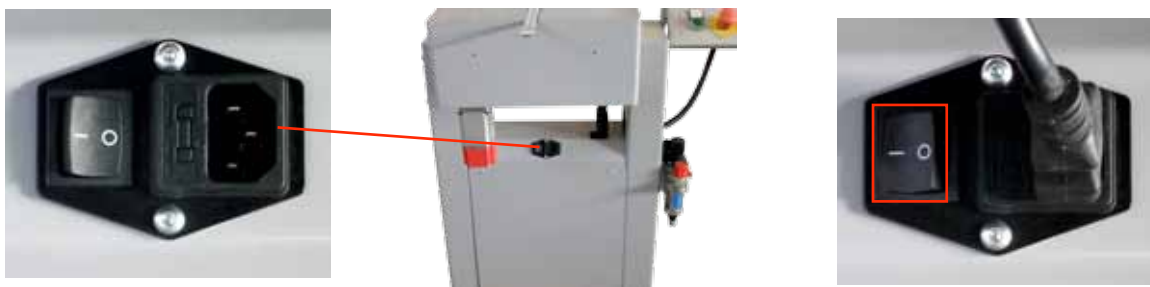

Avoid the use of long extension cables.

Put the switch on "1" which is located on the floor stand to switch on the machine.

Rotate clockwise the emergency mushroom headed button located on the keyboard.

Press the green button of the keyboard to turn motor on and to activate the keyboard controls.

## 4.8 PRELIMINARY CONTROLS

Before setting up the machine, execute checks to prevent mistakes or accidents during setup.

- Verify that machine has not been damaged.
- Verify the integrity of electric boards, control panels, electric cables, wires and pipes
- Check the proper connection of external power sources

## 4.9 MACHINE ARRANGEMENT

### 4.9.1 Wedges magazine loading

To load the wedges magazine proceed as follows:

- On the PanelPC main screen, press the "A" button to open the magazine: the image on button changes and an alarm is set until the magazine is opened.

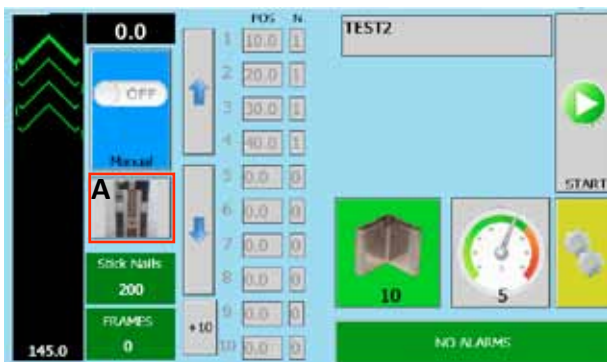

Image 5



Magazine closed



Magazine open

- Insert wedges into magazine paying attention that the gluing side is upward and the sick is turned as shown in image 6



Image 6

- Once the wedge stick is correctly inserted (see image 7), press "A" button to close the magazine (alarm will disappear)



Image 7



**In case the wedge driving group was not in a right position make the magazine easily accessible, use the JOG arrows to move the driving group in the right position (see image 8.)**



Image 8



**TAKE CARE:** When the magazine runs short of wedges, or when it contains an amount of wedges not sufficient to complete a working cycle, machine will stop at the next foot-pedal pressure and warn the operator informing that magazine is running short of Wedges.

*4.8.2 Wedge guide head replacement to change wedges size*

The claw-head must be changed each time you use different sizes wedges.



**For a better functioning of the machine, insert the claw-head with the driver blade pulled. This will ensure a more precise alignment with the guide.**

Proceed as follows to change it:

- Open wedge magazine by pressing the “A” button (see image 5).
- Use a 5mm Allen wrench to loosen the claw head fixing screw then remove and replace the claw head with the proper size one (see Image 9)



Image 9a



Image 9b

- Empty the magazine removing stick and any loose wedges that could be in the magazine (using the proper brass magnet, if necessary - see image10).



Image 10

- Insert the new wedges stick (of desired size) into the magazine (see image 6)
- Close the magazine by pressing the “A” button (see image 5).
- Insert the new size claw head to match the wedges to be used (see fig. 11).





Image 11

- Tighten the locking screw of the Wedge guide head (see image 9a).

## 4.9 ADJUSTMENTS

Since the machine is tested before shipping, the operator has only to execute the following adjustments:

### 4.9.1 Adjustments for wedge positioning

The A5-MemoTS is equipped with a wedge driver mounted on a movable carriage. This is controlled by an electric motor able to fix with good precision each inserting position.

The maximum carriage stroke is 145 mm. Within this stroke you can define several inserting positions. These different points are settled on the program that the operator must input for each working cycle. For further information regarding the programs creation and Wedges inserting positions see chapter 6.

### 4.9.2 Vertical clamp adjustment

To guarantee perfect clamping of the mouldings throughout the several working cycles the machine is equipped with a double hydraulic clamp. It allows the adjustment of both position and height.

#### 4.9.2.A Vertical clamp position adjustment

Position on the working bench the moulding to be assembled

- Loosen the (B) handles (see fig 12a)
- Shift the cylinders, by sliding them along the cross-bar.
- Position the cylinders directly over the moulding to be assembled.
- Tighten the “B” handles (see fig. 12a)
- Loosen the “A” handles (see fig. 12a)
- Access the Manual Commands pressing button “C” (see image 12b)
- Press “D” button (see image 12b) to activate the vertical clamping setting the two pads adapted to the moulding shape

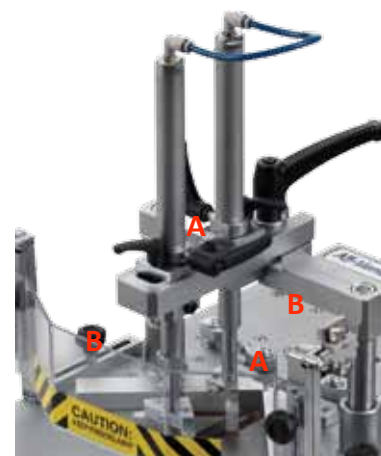

Picture 12a



- Tighten the “A” handles (see fig. 12a)
- Deactivate the vertical clamping by pressing the D button (see Picture 12b)
- Close the Manual Command by pressing the C button (see image 12b).

Picture 12b

#### 4.9.2.B Vertical clamp height adjustment

- Unscrew by using a 6mm allen wrench the “C” screw of picture 4.9.2.B
- Lift the vertical clamp
- Tighten the “C” screw of picture 4.9.2.B
- Activate the vertical clamping (5.4.1.4.1) and then tighten the B handles

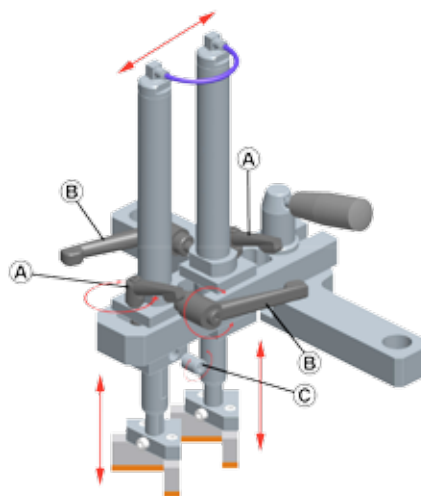

Picture 4.9.2.B

#### 4.9.3 Frontal clamp adjustment

The Front Clamp bar has a series of holes in it. By lifting the bar you can move it from its initial position and reposition it forward or backward.

To lock the bar it is sufficient to insert it into the proper peg in the center of the guide channel.

To properly position the Horizontal Clamp, operate as follows:

1. lift the bar from its peg about 10 - 15 mm and move it forward until reaching the moulding to be assembled;
2. lower the bar & allow it to drop over the peg to lock it in the new position.



**In case of shipment, fix the bar to the work bench by using the supplied screw knob.**

#### 4.9.4 Fence adjustment

The machine is equipped with a special fence composed of 2 different parts.

Each fence side is equipped with a knob that allows it to tilt the moulding supports.

This fence use is recommended to assemble highly profiled mouldings.

Furthermore, if the moulding rolls forward or backwards as the front clamps engages, you can adjust the tilting fence to compensate the effect.

Machine is also equipped with a "Special Tightening Device" that will firmly tighten the corner during the wedge driving operation.



Image 4.9.4



#### 4.9.5 Working pressure adjustment

The working pressure must be adjusted to the hardness of the mouldings to be assembled.

The pressure regulation permits you to change the clamping pressure of mouldings to be assembled.

Too high of a working pressure can cause a poor junction and (especially on small-size frames) the mouldings can be crushed.

Too low of a working pressure can cause an incomplete insertion of the Wedges into the frame.

The working pressure is adjusted by means of the regulator on the panel near the pressure gauge (see fig. 13).

Proceed as follows to adjust the working pressure:



Picture 13

The suggested pressures are:

Soft woods	(samba,. poplar, ...)	1.5 - 2.0 Bar
Medium	(ramin, pine, ...)	2.0 - 3.0 Bar
Very hard woods	(oak, MDF), ...	3.0 - 5.0 Bar



**The above listed values apply to 7 and 10 mm high Wedges.**

**Increase the pressure by 10 % for 15 mm high Wedges.**

**When stacking 2 or more Wedges in the same position, increase the working pressure by 20%..**

#### 4.9.6 Protective shield adjustment

The machine can be ordered with a protective shield made of transparent plastic material.

Proceed as follows to adjust the protection shield:

1. loosen the screw knobs fixing the protection and lift or lower it at an height of about 6-8 mm from the mouldings to be assembled;
2. tighten knobs to lock the protection shield.



**Opening the shield causes the control pedal deactivation.**

Even if the protective shield is properly adjusted, it is necessary to respect the following instructions:

- keep the fingers away from the frontal and vertical clamp working area
- disconnect the pressure supply during any maintenance intervention
- keep the foot separated from the pedal during the machines adjustments

#### 4.10 ITEMS TO BE PERFORMED BEFORE OPERATING THE MACHINE.

Once the machine has been properly installed (like previously described), check that:

- The mouldings to be assembled are properly positioned on the work bench
- The magazine is loaded with the type and size of wedges suitable with the mouldings to be assembled
- The adjustment of vertical and horizontal clamping is correct (chapter 4.9.2 and 4.9.3)
- The machine is connected to the electric network,air and the switches are activated
- The working pressure is adequate to the wood hardness (see chapter 4.9.5)
- The protective shield is properly positioned (see chapter 4.9.6)
- The working cycle has been correctly transmitted and program is in run

After checking the points relating to the above operations,

- Press the pedal full down to activate the machines work cycle

## 5. FUNCTIONING

### 5.1 OPERATORS

The machine has been projected to be used by only one operator.

- The operator, as well as being adequately informed on the use of machinery, must possess skills and competence adequate to the type of working activity to perform.
- Even after being adequately informed, during the first utilization, if necessary, simulate some operating manoeuvres to identify the controls, especially the ones for starting and stopping the machinery and their main functions.
- now how to operate in case of emergency , where to find the individual protection means and how to use them properly.

### 5.2 CONTROL PANEL

Control panel is composed by:

- the Panel PC that allows the operator to dialogue with machine
- the Motor-on button that switches the machine to be operational
- the Emergency button that stops machines when pressed

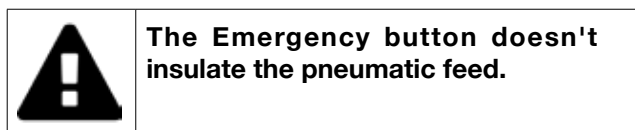

- the JOG buttons (+/-) that make the wedges driving group to move along the stroke



### 5.3 MODE OF OPERATION

The A5-MemoTS allows the operator to create customized working cycles according to size and profile of mouldings to be assembled.

The machine has only one operating mode:

- Semi-automatic operating mode using programs created by the operator

### 5.4 SOFTWARE INTERFACE

Switching the machine on, after that Operative System has been loaded, the software interface is launched. The following is displayed on the screen:



When the software interface finished loading, it is requested to the operator to release Emergency button, to press Motor-ON button and to proceed with the driving group homing. The request messages appear:

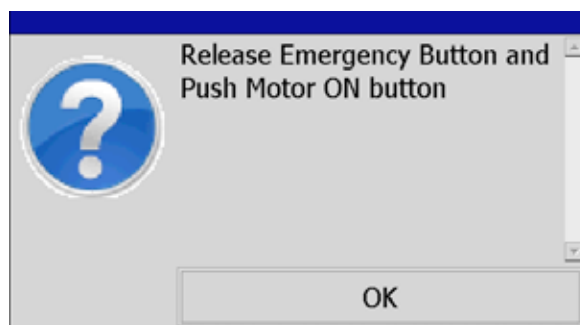

Request to release Emergency and press Motor-ON

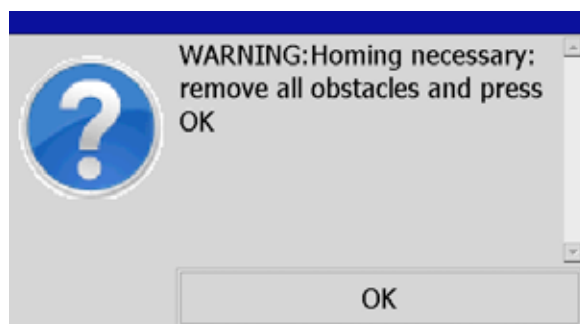

Request to proceed with driving group homing

At the end of homing operation the main screen appears.

5.4.1 Commands and information on main screen

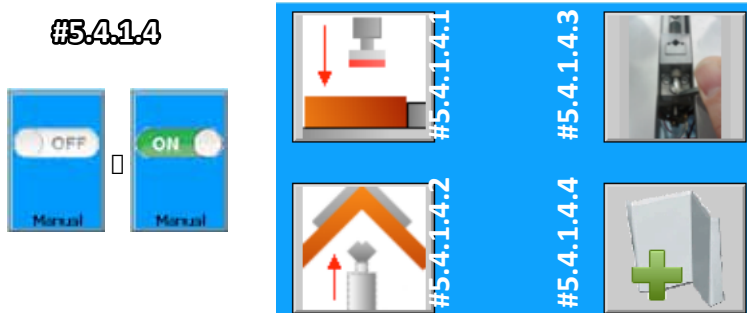
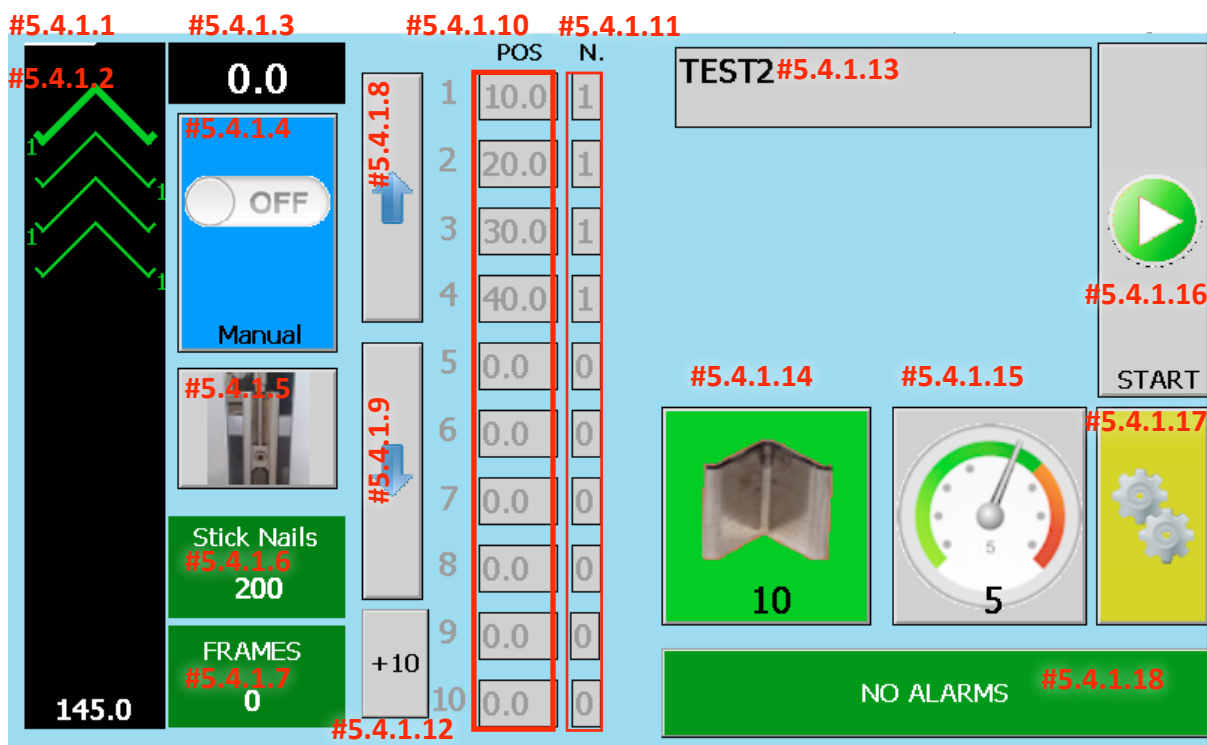

- #5.4.1.1 Indicates the stroke within which moves the firing head;
- #5.4.1.2 Graphically indicates the position of the firing head according to the measure written at the insertion point (# 5.4.1.11);
- #5.4.1.3 Represents the position in mm in which the driving head is;
- #5.4.1.4 This button enables/disables the access to Manual Commands;
- #5.4.1.4.1 This button enables/disables the vertical pressure clamping to check the correct positioning of the vertical clamping device;
- #5.4.1.4.2 This button enables/disables the horizontal pressure clamping to verify the correct positioning of the terminal;
- #5.4.1.4.3 This button activates the displacement of the driving group to furthest side, allowing easy access to the claw head. Pressing it again, the driving group returns to the previous position;
- #5.4.1.4.4 This button allows to manually drive a wedge each time it is pressed (the function is active only after having pressed the pedal that activates the vertical and horizontal clamps);
- #5.4.1.5 This button opens/closes the wedges magazine when it is necessary to refill;
- #5.4.1.6 Value indicating the amount of wedges in the magazine (this amount is reset to 200 each time the magazine is opened and closed);
- #5.4.1.7 Value indicating the amount of frames produced from power on for the running program. This value will be reset to the shutdown and/or program change;
- #5.4.1.8 Button that moves forward the driving position selection box (# 5.4.1.10);
- #5.4.1.9 Button that moves backward the driving position selection box (# 5.4.1.10);
- #5.4.1.10 List of driving positions, from 1 to 14. The digits within each box in correspondence of the number list is the position in mm in which will be inserted the wedge (Note: positions 11 to 14 are visible by pressing the #5.4.1.12 button);
- #5.4.1.11 The digits (1 to 9) indicates the quantity of wedges that the machine will drive in correspondence of the position to the left (list # 5.4.1.11);
- #5.4.1.12 Button through which to view and edit the wedges driving positions 11 to 14;
- #5.4.1.13 Section/list that displays the name of the running work cycle. By clicking on the area, you enter the list of stored cycles;
- #5.4.1.14 Button through which set the size of wedges to be used

within the selected working cycle;

- #5.4.1.15 The digit (1 to 8) indicates the running cycle working speed. By pressing the button, you enter the working speed selection window;
- #5.4.1.16 By pressing this button, the cycle selected from the list #2.2.14 is put into execution;
- #5.4.1.17 Button to access options and parameters;
- #5.4.1.18 In this section (usually green) are indicated alarms: in this case, the button turns red and clicking it, you enter the list of active alarms.

## 5.5 DESCRIPTION OF MAIN SCREEN FUNCTIONS

### 5.5.1 Wedges magazine open

The #5.4.1.6 button, activates the command that operate the open of wedges magazine (the button icon changes state). Pressing the button again, the command is canceled.

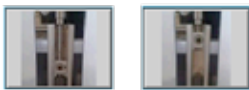

### 5.5.2 Horizontal and Vertical clamping control

Access to the manual commands by pressing the #5.4.1.4 (the button icon changes state)



#### 5.5.2.1 Horizontal clamping adjustment check

The #5.4.1.4 button click activates the cylinder that operates the horizontal clamp (the button icon changes state). Pressing the button again, the command is cancelled.



#### 5.5.2.2 Vertical clamping adjustment check

The #5.4.1.5 button click activates the command that operates the vertical clamp (the button icon changes state). Pressing the button again, the command is cancelled.



### 5.5.3 Wedges insertion points check

Pressing the #5.4.1.8 and #5.4.1.9, we obtain the displacement of the wedges driving group along the working stroke at the points where the program will go to insert the wedges. Each time you press, the next position, with respect to the direction of movement, change color indicating where the driving group is

located. On the left side of the page, in line with the movement, you will also have displacement of the head picture.



### 5.5.4 Wedges size

Pressing the #5.4.1.15, one can select the height of the wedges.

This data is only information for the operator to which it is indicated the height of wedges to be used for the proper performance of the selected work cycle. Press the button corresponding to the height of wedges necessary to execute cycle.



### 5.5.5 Work cycle execution speed

Pressing the #5.4.1.16, one can select the speed. The execution speed must be compatible with the hardness of the material to be joined: the harder the material, the slower will be the work cycle execution. There are 8 speed.

Press the button with the "Turtle" to decrease the speed; press the button with the "Rabbit" to increase it. Once defined execution speed, press the "V" button to confirm.







### 5.6 EXECUTION OF AN EXISTING WORKING CYCLE

Clicking on #5.4.1.13, a combo box opens showing the recorder working cycle list. Scroll the list and select the working cycle to execute. Pressing the #5.4.1.16, the current work cycle is transmitted to machine.

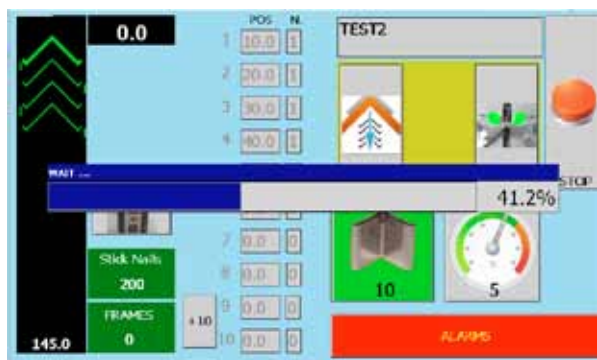

Two new buttons appear on the screen:

- #5.6.1 pressing this button, the driving group moves forward at a point easy for the operator to change the claw head (see also Chap. 4.8.2);



- #5.6.2 allow to disable the special "frame tightening" device



Pressing the pedal, the machine will perform the work cycle.

	<b>NOTE:</b> THE PEDAL MUST BE KEPT PRESSED UNTIL COMPLETION OF THE WORKING CYCLE BEFORE BEING RELEASED.
--	---

	<b>Each time you press the pedal, the loop will run.</b>
--	--

The pedal will remain OPERATIONAL until you press the STOP button.

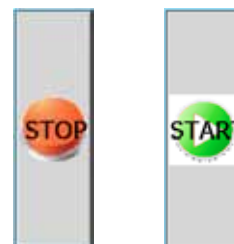

## 5.7 OPTIONS AND PARAMETERS

Pressing the #5.4.1.18 button, you access the Options and Parameters page.

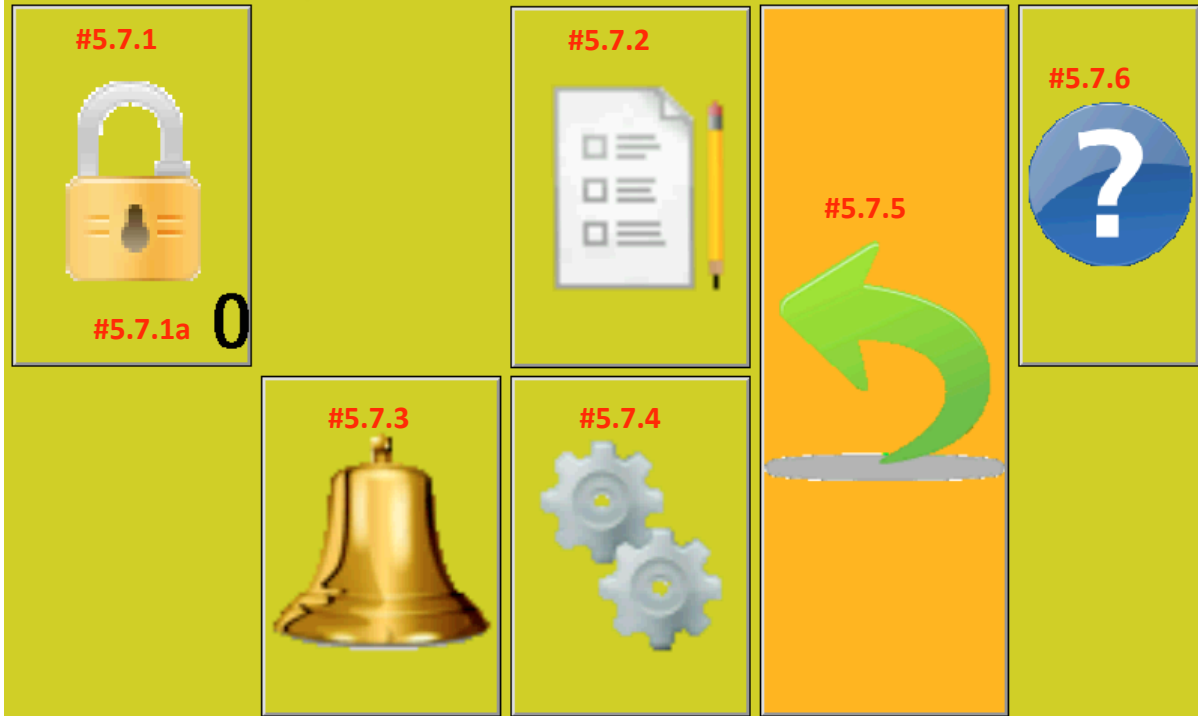

- #5.7.1 Button to access password input page;
- #5.7.1.a Indicates the current access level: 0 the lowest.
- #5.7.2 Button to access working cycle list;
- #5.7.3 Button to access the alarms list;
- #5.7.4 Button to access settings page;
- #5.7.5 Button to return to the main screen;
- #5.7.6 Software and Firmware version information

### 5.7.1. Password entering

The machine is designed for different levels of password that are matched different levels of operators: from the most basic to the super user.

In original condition, two users are registered:

- **User Level 0** – No password (can use the machine but cannot create or modify work cycles);
- **User level 5** - password 9999 (can create and / or modify the work cycles as well as change some parameters and/or setup options)
- **User level 10** - daily password, to be applied to A-Plus Automation (user maintenance of high level: it can access all the options and parameters of the machine).

By pressing the lock button, a keypad appears:

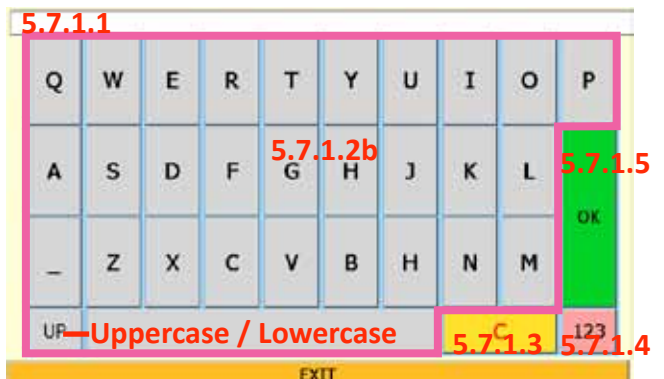
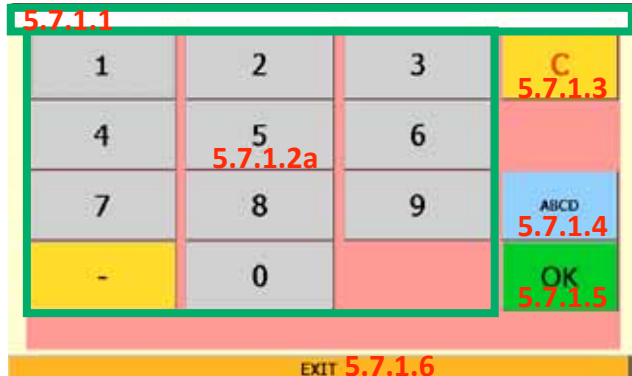

- #5.7.1.1 Password insertion field;
- #5.7.1.2a Numeric keypad for entering a password. Pressing the # 5.7.1.4a, letters appears instead of numbers (# 5.7.1.2b);
- #5.7.1.3 Delete (backspace)
- #5.7.1.4 Switches from digits to letters
- # 5.7.1.5 Confirm and return to the previous menu

5.7.2 Working cycle list

ID	Descr	Speed	Nail
4	CYCLE_DE_TEST_123	5	12
1	TEST	8	10
3	TEST_3	6	10
2	TEST2	5	10

#5.7.2.1

#5.7.2.2 UTIL Descr 00000 #5.7.2.4 UTIL Descr 00000 #5.7.2.4  
 #5.7.2.3 3/4 #5.7.2.5 #5.7.2.5  
 #5.7.2.2 EDIT UTIL Descr 00000 #5.7.2.4 UTIL Descr 00000 #5.7.2.4  
 #5.7.2.3 3/4 #5.7.2.5 #5.7.2.5

The functions available in the work cycles section are discriminated according to the operator level. The base operator (level 0 or 1) can only browse, search and run existing work cycles. The level 5 or higher operators, will instead create, edit and delete cycles. In the image above, the commands/sections indicated in green are for the level 5 operator while sections in red are available to all operators/users.

- #5.7.2.1 List of stored work cycles
- #5.7.2.2 Edit button (**only for operators of level 5 or higher**). By pressing the button, the menu changes and operations are available for work cycles creation, editing, duplication and deletion.

#5.7.2.2.1 #5.7.2.2.3 #5.7.2.2.5  
 #5.7.2.2.2 #5.7.2.2.4

- #5.7.2.2.1 By pressing this button, you access the page to creating a new program.

Description #5.7.2.2.1.1

POS 1	0.0	0
POS 2	0.0	0
POS 3	0.0	0
POS 4	0.0	0
POS 5	0.0	0
POS 6	0.0	0
POS 7	0.0	0

#5.7.2.2.1.4 MORE #5.7.2.2.1.5 WIDTH 102.5 145.0 #5.7.2.2.1.12 OK  
 #5.7.2.2.1.6 #5.7.2.2.1.7 #5.7.2.2.1.8 #5.7.2.2.1.9 #5.7.2.2.1.10 #5.7.2.2.1.11 #5.7.2.2.1.13

- #5.7.2.2.1.1 Enter a name (alphanumeric) that identifies the work cycle
- #5.7.2.2.1.2 For each of the positions (1 to 14) where you want to insert one or more wedges, enter the position in mm (or inches – see par. 5.7.4);
- #5.7.2.2.1.3 Insert, for each of the programmed insertion positions the quantity of wedges (1 to 9) to be inserted in the position;
- #5.7.2.2.1.4 Allows to access to inserting positions from 8 to 14;
- #5.7.2.2.1.5 Enter the width in mm (or inches - see Par 5.7.4) of

the junction.

- #5.7.2.2.1.6 Set the insertion point of the wedge defined by a JOG movement.
- #5.7.2.2.1.7 Graphic presentation of the programmed driving wedges positions.

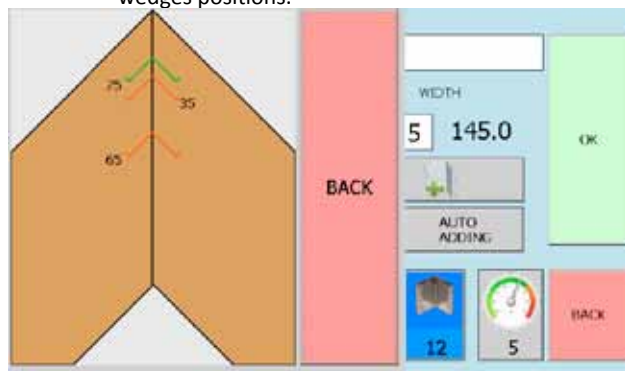

- #5.7.2.2.1.8 Automatically create a sequence of wedge driving positions based on the junction width input on the #5.7.2.2.1.5.
- #5.7.2.2.1.9 This button allows to change the program execution direction: from the first to the last or from the last to the first.
- #5.7.2.2.1.10 Define the height of wedges that the operator will have to use to execute work cycle (see par. 2.2.5).
- #5.7.2.2.1.11 Select the work cycle execution speed (see par. 5.5.5).
- #5.7.2.2.1.6 Press it to confirm and save the work cycle.
- #5.7.2.2.1.6 Press it to return to the previous screen and undo what you set here.
- #5.7.2.2.3 Pressing this button, it is possible to edit an existing work cycle.

Description TEST2

POS 1	10.0	1
POS 2	20.0	1
POS 3	30.0	1
POS 4	40.0	1
POS 5	0.0	0
POS 6	0.0	0
POS 7	0.0	0

#5.7.2.2.1.4 MORE #5.7.2.2.1.5 WIDTH 102.5 145.0 #5.7.2.2.1.12 OK  
 #5.7.2.2.1.6 #5.7.2.2.1.7 #5.7.2.2.1.8 #5.7.2.2.1.9 #5.7.2.2.1.10 #5.7.2.2.1.11 #5.7.2.2.1.13

For each position, you can edit distance and quantity of wedges to be driven; similarly can be changed the speed and the wedges sizes. Once finished, press OK to confirm or BACK to cancel.

- #5.7.2.2.3 Pressing this button, it is possible to copy an existing work cycle. Once the button is pressed, the work cycle screen appears: insert a new name and confirm by pressing OK to paste and save; press BACK to cancel.
- #5.7.2.2.4 By pressing this button, it is possible to delete one or more existing work cycles.

ID START: 1 ID END: 1 DELETE NO

ID START is the work cycle Id to start from; ID END is the work cycle Id to finish with;

Once the range is defined (it can be also one), press DELETE to confirm the action. Press NO to abort the operation

#5.7.2.2.5 By pressing this button you return to the previous screen.

#5.7.2.3 By pressing this button, you enter the work cycles search, export and import section. *The export and import buttons are only available for level 5 or higher users.*

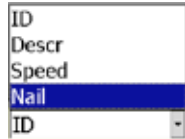

#5.7.2.4 Press this button to execute the selected work cycle.

#5.7.2.5 Return to the previous screen.

### 5.7.3 Alarm list history

This section lists the occurred alarms.

Prg	Date-Time	Description
361	1/24/2015 3:51:54	1 0
360	1/24/2015 3:13:58	0 72
359	1/24/2015 3:13:42	0 72
358	1/24/2015 3:11:25	1 0
357	1/24/2015 3:04:00	0 74
356	1/24/2015 3:03:47	0 2
355	1/24/2015 3:03:41	1 2
354	1/24/2015 2:47:15	1 2

#5.7.3.3 CLEAR #5.7.3.3 VIEW #5.7.3.4 BACK

#5.7.3.1 On the list alarms are normally sorted by date and time.

#5.7.3.2 Combo box through which change the sort key using the progressive (PRG) or Description.

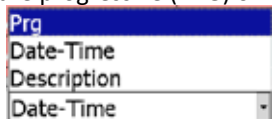

#5.7.3.3 By pressing this button, all the alarm history is erased.

#5.7.3.4 By pressing this button, the selected event on the list # 5.7.3.1 is opened in order to have more information about the event.

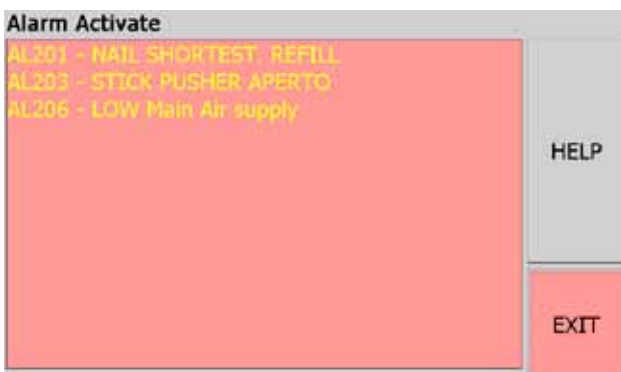

#5.7.3.5 Return to the previous screen

### 5.7.4. Parameters

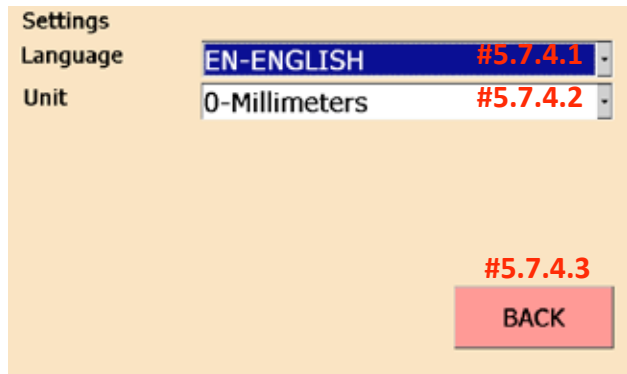

#5.7.4.1 Combo box through which you can change the interface language.

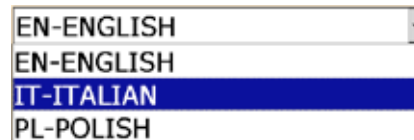

To change, just click on the desired language

#5.7.4.2 Combo box through which change the scale from mm to inches.



To change, just click on the desired scale

#5.7.4.3 Pressing this button returns to the previous section.

### 5.7.5 Software and Firmware versions

This section contains the information on software and firmware versions installed on the machine





#5.7.5.1 Click on the combo box to get the information

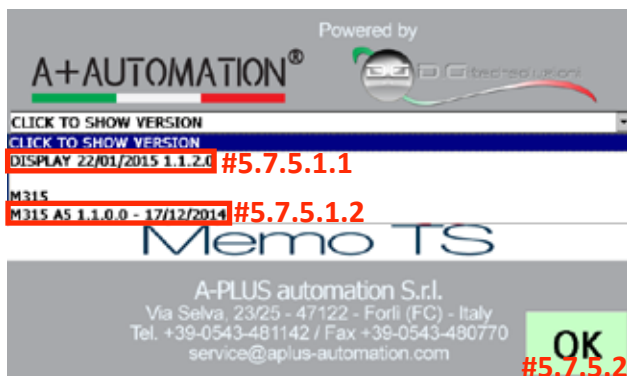

- #5.7.5.1.1 Indicates the version of the software interface
- #5.7.5.1.2 Indicates the firmware version of the machine
- #5.7.5.2 Press this button to return to the previous section

### 5.8 TIPS FOR PERFECT JUNCTIONS

a) Wedges  
 In order to allow the machine to make excellent quality junctions using different materials, it has been necessary to manufacture different wedges types for different uses.  
 Wedges can be classified in three different groups:

Material	Suggested code
soft materials (wood, soft plastic)	SW (green)
for medium materials (wood, ...)	MW (gray)
for hard materials (wood, MDF, HDF)	HW (red)

- b) Assembling positions  
 It is advisable to operate as follows in order to achieve the best results in terms of junction quality:
- Never drive wedges near the junction vertex. The minimum recommended distance from the external vertex is at least 10 mm.
  - When you want to make the junction using a single wedges, the most suitable position is in the center of the moulding.
  - In case you want to insert 2 or more wedges into each junction, we recommend you to insert the most external one 1/3 from the external vertex and

the most internal one 1/4 from the internal vertex.

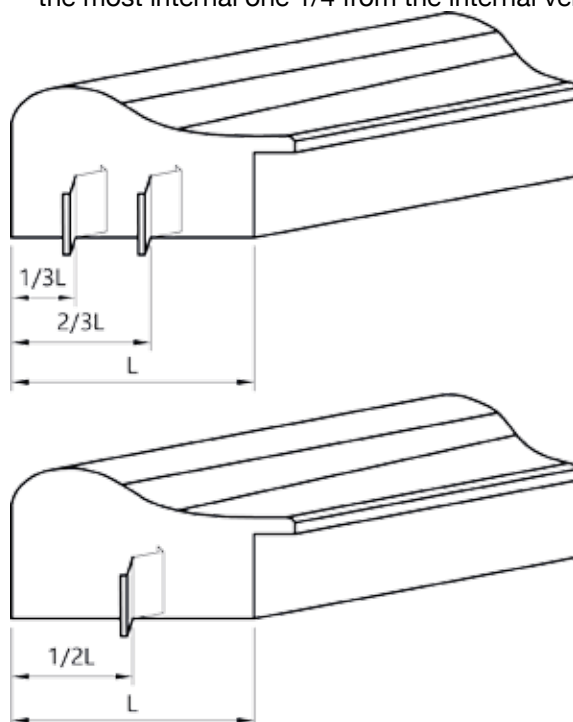

### 5.9 MACHINE STOP

The machine can work only by pressing the electric pedal; to stop it mid-cycle press the red Emergency stop button on the control panel.

**The Emergency button doesn't insulate the pneumatic feed.**

#### 5.9.1 Putting out of service

In case on long inactivity periods it is necessary to disconnect the quick disconnect fitting from pneumatic system and the power supply cord.

## 6. QUICK GUIDE

### 6.1 CREATION OF A WORK CYCLE

To program a frame, operate as follows:  
From the Main Screen, press "Option and Parameter" button



Then press the Lock button and input the "9999" code when prompted



Press the Working Cycles button



Then Edit and finally New



Input a name in the name field (see par. 5.7.2.2.1.1), define positions and wedge quantity to be inserted on each position (see par. 5.7.2.2.1.2 - 5.7.2.2.1.3). Define the execution speed (see chap. 5.5.5) and the wedge size:



Then confirm clicking OK button.

To execute the cycle just create, be sure that it is selected on the list and press EXE button:

ID	Descr	Speed	Nail
4	CYCLE_DE_TEST_123	5	12
1	TEST	8	10
3	TEST_3	6	10
2	TEST2	5	10

  

EDIT	UTIL	Descr	00000	3/4	EXE	BACK
------	------	-------	-------	-----	-----	------

The program returns to the main screen:

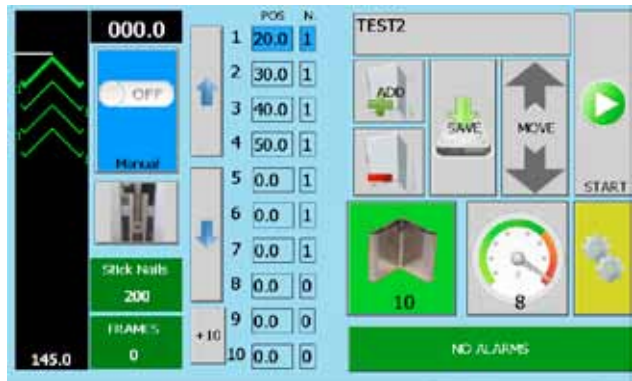

To start production, press the START button: the working cycle is now transferred to the machine.

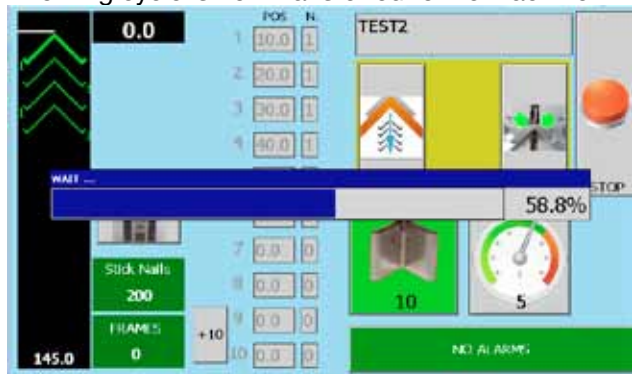

Put the moulding in position on the working bench and press the pedal to execute the cycle

**NOTE:**  
THE PEDAL MUST BE KEPT PRESSED UNTIL COMPLETION OF THE WORKING CYCLE BEFORE BEING RELEASED.

Each time you press the pedal, the loop will run.

The pedal will remain OPERATIONAL until you press the STOP button:

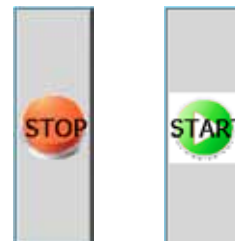

### 6.2 CHANGES ON THE FLY

When the user level 5 is set, it is possible, if necessary, to change the working cycle on the fly without to pass through the editing.

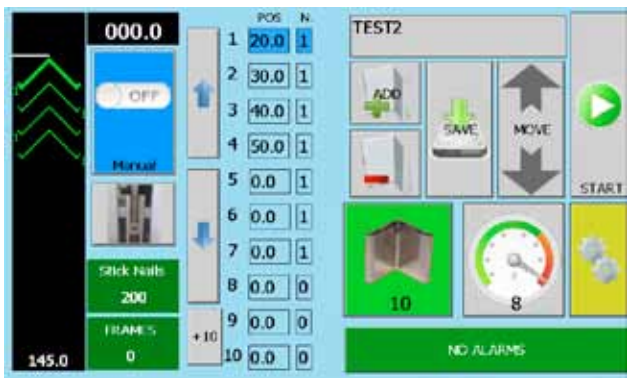

**Speed change**

Press the speed button and select the new working speed.



**To make the changes recorded, press the SAVE button**



**Please apply to the Software Manual for more information.**

**Position change**

Clicking on position it is possible to change it by entering (through the keypad that will automatically opened) the new value;

**Wedge quantity change**

Clicking on wedges quantity it is possible to change it entering the new quantity;

**Addition of new position**

To add a new position, there are two possible ways:  
 If the position distance is already known, just click in an empty position and add the value and then the wedge quantity to be driven (or press the MOVE button, enter the value and once the insertion driver group reached the position press the ADD/+ butto. Then check or modify the wedge quantity);  
 If the position is not known, use the JOG buttons



to reach the desired point of insertion.  
 The Press ADD/+ button and adjust the wedge quantity.

**Deletion of an insertion point**

Move the selector using the Up/Down arrows



When the point to be deleted is reached, press the minus “-” button.

## 7. BACKUP, TRANSFER, CODIFY

### 7.1 BACKUP

Each time the software is launched (or machine is turned on), a backup is automatically executed.

It is possible to copy the programmed cycles using the an USB pen.

Logon with the Level 5 password “9999” (see chap. 5.7.1).

Enter in Parameter section (see chap. 5.7.4).

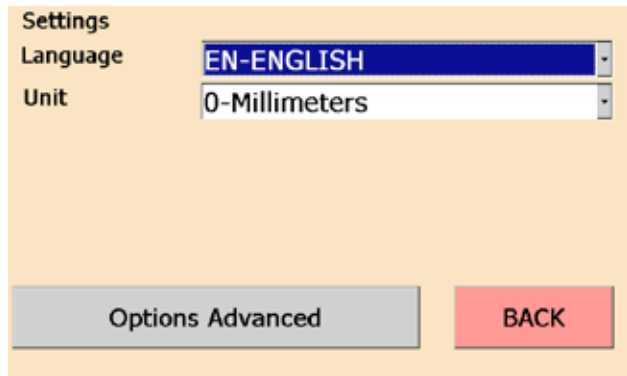

and press the “Option Advanced” button.

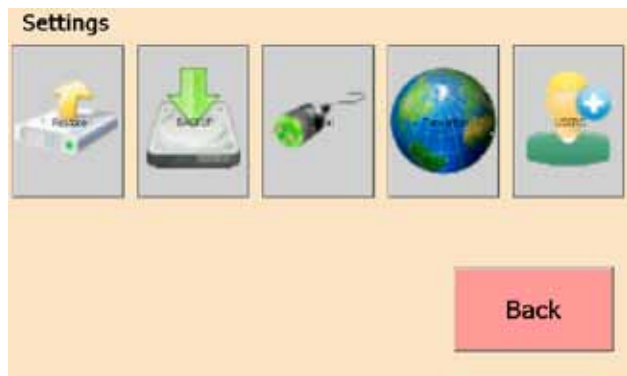

Press the BACKUP button

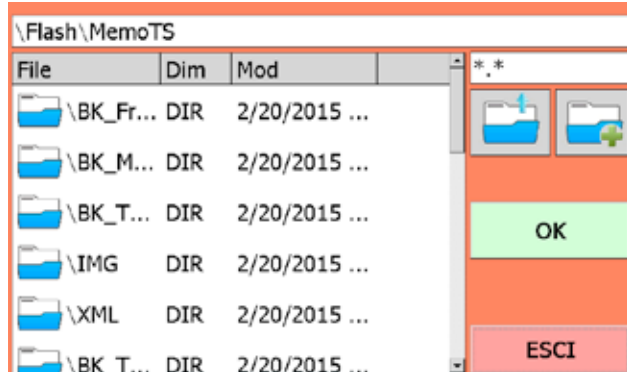

Press the Up Dir button until the root directory is

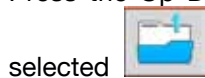

selected

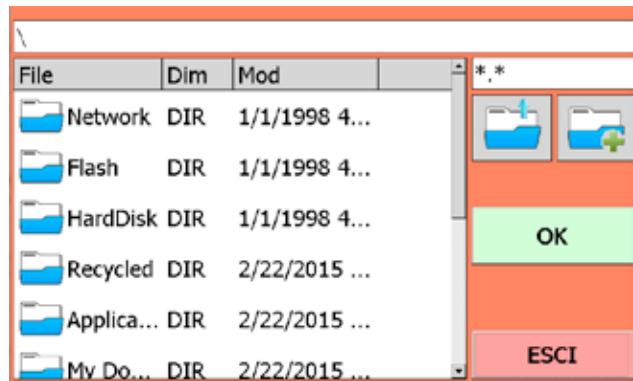

Then select the “HardDisk” directory that corresponds to the inserted USB pen.

Double click to access the disk and press the create directory button



The system will prompt the operator for the directory name



Click in the name field and using the keypad that appears, input a name for the backup directory and click OK.

Select the newly created directory and press OK button

The system asks if operator wants to backup all tables: press OK

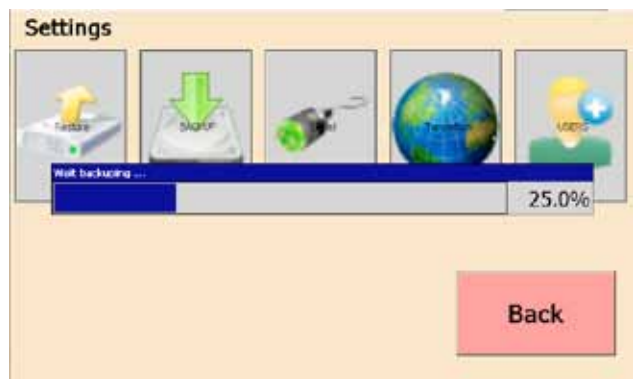
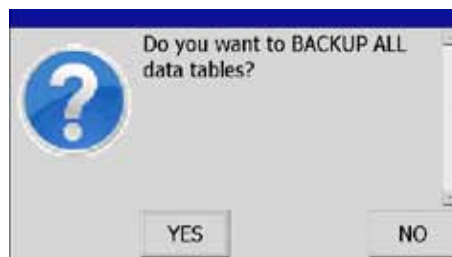

When the backup finishes, the Settings menu appears again



### 7.2 RESTORE / TRASNSFER

First insert the USB pen containing the backup files and proceed similarly as described in the previous chapter until you reach the Settings menu.

Pressing the RESTORE button, the system propose to

- Restore all ALL Data files
- Restore ONE Data file



In case the restore operation is direct to copy the working cycles from a machine to another, press the “Restore ONE Data file” button

As seen in the previous chapter, press the Up Dir button till the root directory (\)



then double click the HardDisk directory to enter the USB drive.

Again double click on the directory that contains the backup .

Then scroll down to look for the programs data file

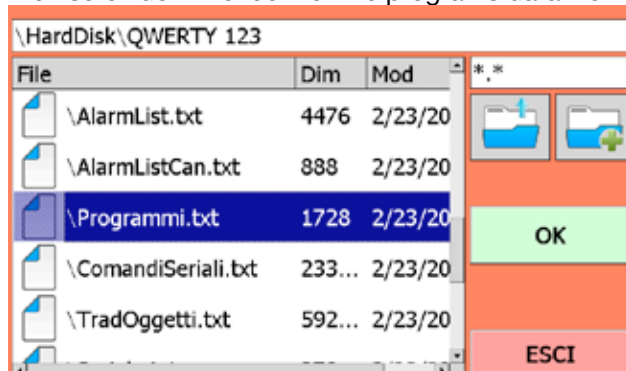

Then press OK to confirm the operation.

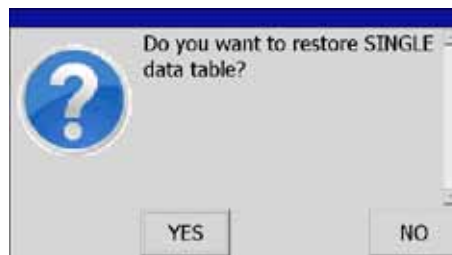

Click YES to confirm

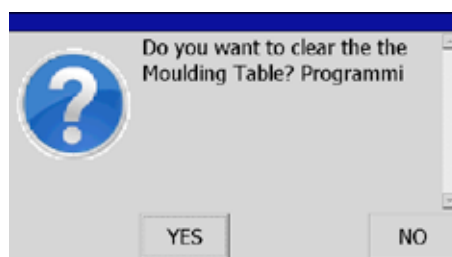

Click NO: in this way, the programs from restore will be add to the machine.

### 7.3 CODIFY PROGRAMS THROUGH BARCODE

It is possible to identify the frame to be joined through a barcode. Using a barcode decoder (see picture 7.3.1) the working parameters are conveyed to the machine



Picture 7.3.1



**Use scanner type CCD, laser or similar; configured to be used with serial iniface RS 232 OR USB**

The scanner must be connected to the suitable connector which is placed on the back side of keypad (see chap. 4.6.2).



## 8. MAINTENANCE

### 8.1 RECOMMENDATIONS FOR MAINTENANCE

Carry out maintenance or repair operations with the machine isolated from all power supplies, as indicated by the Manufacturer.

	<ul style="list-style-type: none"> <li>• <b>Press the 5.6.1. button. This will position the driver head to the maintenance position.</b></li> </ul>
---	---

Before performing any type of maintenance or repair, it is necessary to isolate the machine from the feeding sources, making the following operations:

1. Disconnect the plug from the electric socket.
2. Disconnect the quick connect fitting from from the air supply.

During the maintenance or repair operations we suggested to proceed as follows:

- Before starting any operation place a sign-board “machine under maintenance” in a well visible position
- Do not use solvents or flammable materials
- Do not step on the machine parts, because they have not been projected to sustain the weight of persons.
- Disconnect the power supply from the electric system & disconnect the air supply
- Once all the operations are finished, restore and place properly the protections and shields removed or opened.

### 8.2 CLEANING THE MACHINE

Keep the machine in maximum efficiency conditions and perform all the scheduled maintenance operations provided by the manufacturer. Good maintenance will result in better performance, a longer operating life and keep the safety requirements unchanged over time.

Follow the rules listed below:

- Regularly remove glue or other residues from the claw-head and from the upper part of the driver blade;
- always keep the wedges magazine clean
- remove any residue from the wedges guide “L” shaped support.

Do not use water to clean the machine, otherwise the metallic parts may rust.

	<p><b>Before performing any cleaning intervention, the operator must disconnect the electric and the pneumatic systems.</b></p>
---	---

### 8.3 ROUTINE MAINTENANCE OPERATION

Frequency	Inspection	Action
Every 1.000.000 wedges shot	wedges driver blade	Replace
Every 300 working hours	Movable parts lubrication	Lubricate
Every 5.000.000 wedges shot	Wedges claw-heads	Replace
Every 5.000.000 wedges shot	“L” shaped supports (wedges guide)	Replace
20 million of wedges shot	Valves and Reducers	Check and in case, replace
Every 6.000.000 wedges shot	Frontal and vertical clamping gaskets	Replacement in case of leak of air

### 8.4 RECOMMENDED OIL

Use CASTROL MAGNA GC 32 or equivalent oi

	<p><b>Unsuitable lubricants may cause valve seal problems (seals may become too large) and consequent Valve jamming.</b></p>
---	--

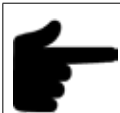

**If you use glue when joining frames, we suggest you lubricate the driver blade daily.**

## 8.5 ORDINARY MAINTENANCE

The following operations must be executed on the times indicated here below. Not observing the following instructions exonerate the Producer from any responsibility regarding the warranty.

The operations described here below, even if simple, must be executed by qualified personnel.

The scheduled ordinary maintenance includes overhauls, checks and interventions that, to prevent stops and breakdowns, keep under systematic control:

- Lubrication state of the machine
- Wear and tear parts state.

## 9. DIAGNOSTIC

### 9.1 SAFETY WARNING

The following interventions must be performed by personnel properly trained and you must take all precautions in order to avoid accidental starts.

During the tests, remove the vertical clamp assembly or position it to its full upwards position.

### 9.2 BREAKDOWN SEARCH

Functional inconveniences (causes/remedies)

#### 9.2.a Pressing the foot pedal the wedge does not drive normally

POSSIBLE CAUSE	REMEDY
Insufficient working pressure	<ul style="list-style-type: none"> <li>• The minimum value should be higher than 4 Bar</li> </ul>
wedges positioned wrong into the magazine	<ul style="list-style-type: none"> <li>• The sharpened side (glued side) must be facing up</li> <li>• The V vertex of wedges must face the machines rear side</li> </ul>
Insufficient pressure on the Wedge feed cylinder	<ul style="list-style-type: none"> <li>• The regulator pressure must be at least 1.0 bar. If necessary increase it 10%.</li> </ul>
Claw head not suitable with Wedges height	<ul style="list-style-type: none"> <li>• The number engraved on the claw head must correspond to the Wedges height</li> </ul>
Defective Wedges	<ul style="list-style-type: none"> <li>• Replace the wedges by taking them from a different box</li> </ul>

#### 9.2.b Pressing the foot pedal the machine does not work

POSSIBLE CAUSE	REMEDY
Insufficient working pressure	<ul style="list-style-type: none"> <li>• The air pressure coming out from the compressor must be at least 3 Bars</li> </ul>
Wedge magazine open	<ul style="list-style-type: none"> <li>• Close the magazine by pressing the appropriate button</li> </ul>

#### 9.2.c After several cycles the machine becomes discontinuous

POSSIBLE CAUSE	REMEDY
Jammed valves because of water or oil surplus	<ul style="list-style-type: none"> <li>• Eliminate the water or oil surplus by disconnecting one by one the control pipes to make the air pressure force out the water or oil</li> </ul>
Defective valves	<ul style="list-style-type: none"> <li>• Replace the control valves</li> </ul>

**9.2.d Pressing the electric pedal the machine does not work**

<b>POSSIBLE CAUSE</b>	<b>REMEDY</b>
There is no air in the pneumatic system	<ul style="list-style-type: none"> <li>• Verify that the compressor is running and the drains are closed</li> </ul>
There is no power	<ul style="list-style-type: none"> <li>• Verify that the main switch is turned on and the machine is connected with the electric network</li> <li>• If the machine is connected and there is power, verify that “power on” is turned on</li> </ul>

**9.2.e The electronic part does not work**

<b>POSSIBLE CAUSE</b>	<b>REMEDY</b>
Machine disconnected from the electric network or one or more interrupted fuses	<ul style="list-style-type: none"> <li>• Connect the machine with the electric network</li> <li>• Unscrew the panel located on the rear side of the floorstand: verify by using a tester the fuses continuity and replace it if necessary</li> </ul>
Wrong voltage	<ul style="list-style-type: none"> <li>• Connect the machine to a 220V or 120 V socket</li> </ul>
If the above listed conditions are correct and the failure still exists	<ul style="list-style-type: none"> <li>• Call A-Plus Automation or your local distributor’s Assistance service</li> </ul>

**9.2.f Wishing to insert several wedges one upon the other in the same point, they do not stack properly or tilt during their insertion**

<b>POSSIBLE CAUSE</b>	<b>REMEDY</b>
Wrong Wedges	<ul style="list-style-type: none"> <li>• Replace the Wedges with the proper ones</li> </ul>
Improper clamping, (the frame moves during the insertion of Wedges)	<ul style="list-style-type: none"> <li>• Verify and if necessary adjust the vertical and frontal clamps positions</li> <li>• Increase the pressure by using the regulator</li> </ul>

**9.3 TECHNICAL SERVICE REQUEST PROCEDURES**

For any requirement, please contact the Manufacturer’s Customer Service.

For any request for technical service, list the data on the identification plate, the approximate number of hours the machinery has been used and the type of malfunction.

**E\_Mail: [service@a-plusautomation.com](mailto:service@a-plusautomation.com)**

**FAX: +39-0543-480770**

**Via Selva, 23/25 - 47122 Forlì - Italy**

In the USA please contact:

**E\_Mail: [service@a-plusautomationusa.com](mailto:service@a-plusautomationusa.com)**

**FAX: 248-851-8777**

**31874 Northwestern Highway  
Farmington Hills, MI 48334**



## 10. SPARE PARTS

### 10.1 SPARE PARTS LIST

Even if the machine has been submitted to several tests and functional checks, we list here below the components and relative amounts (in brackets) that we suggest to have a minimum and sufficient set of spare parts to guarantee the least amount of down time as possible.

COMPONENT
WEDGE DRIVER BLADE
WEDGE CLAW HEADS
“L” SHAPED SUPPORT (WEDGES GUIDE)
VALVES-REDUCERS-REGULATORS
VERTICAL AND HORIZONTAL CLAMPING GASKETS

### 10.2 SPARE PARTS ORDERING

We remind you that only a qualified technician can repair the machine.

Thus, we suggest the intervention of A-Plus Automation's or your local distributor's Center of Technical Assistance, which has the qualified staff, proper equipment and tools, and uses original spare parts.

To order the spare parts listed above, send by fax, e-mail or letter (see chapter 9.3) the following data:

- Model of the Machine
- Code of mechanical drawing
- Reference number of spare part or group indicated on the mechanic drawing
- Code/part number of single or group spare part

## 11 MACHINE DEMOLITION

### 11.1 MACHINE DEMOLITION

When scrapping the machine, group components by chemical composition and dispose of separately in accordance with applicable legislation.

Do not dispose of non-biodegradable materials, lubricant oils and non-ferrous articles (rubber, PVC, plastics etc.) in the environment.

## 12. ATTACHMENTS

### 12.1 DECLARATIONS

You can find here attached the following declarations:

- Declaration of conformity to the Norm 2006/42/CE
- Declaration of conformity to the Norm 2004/108/CE

### 12.2 SCHEMATICS

You can find here attached the following schemes:

- (A) Mechanical Schematic
- (B) Pneumatic Schematic
- (C) Plate Location
- (D) Sharpening Table
- (E) Electrical Schematic

ATTACHMENT A - MECHANICAL SCHEMATIC

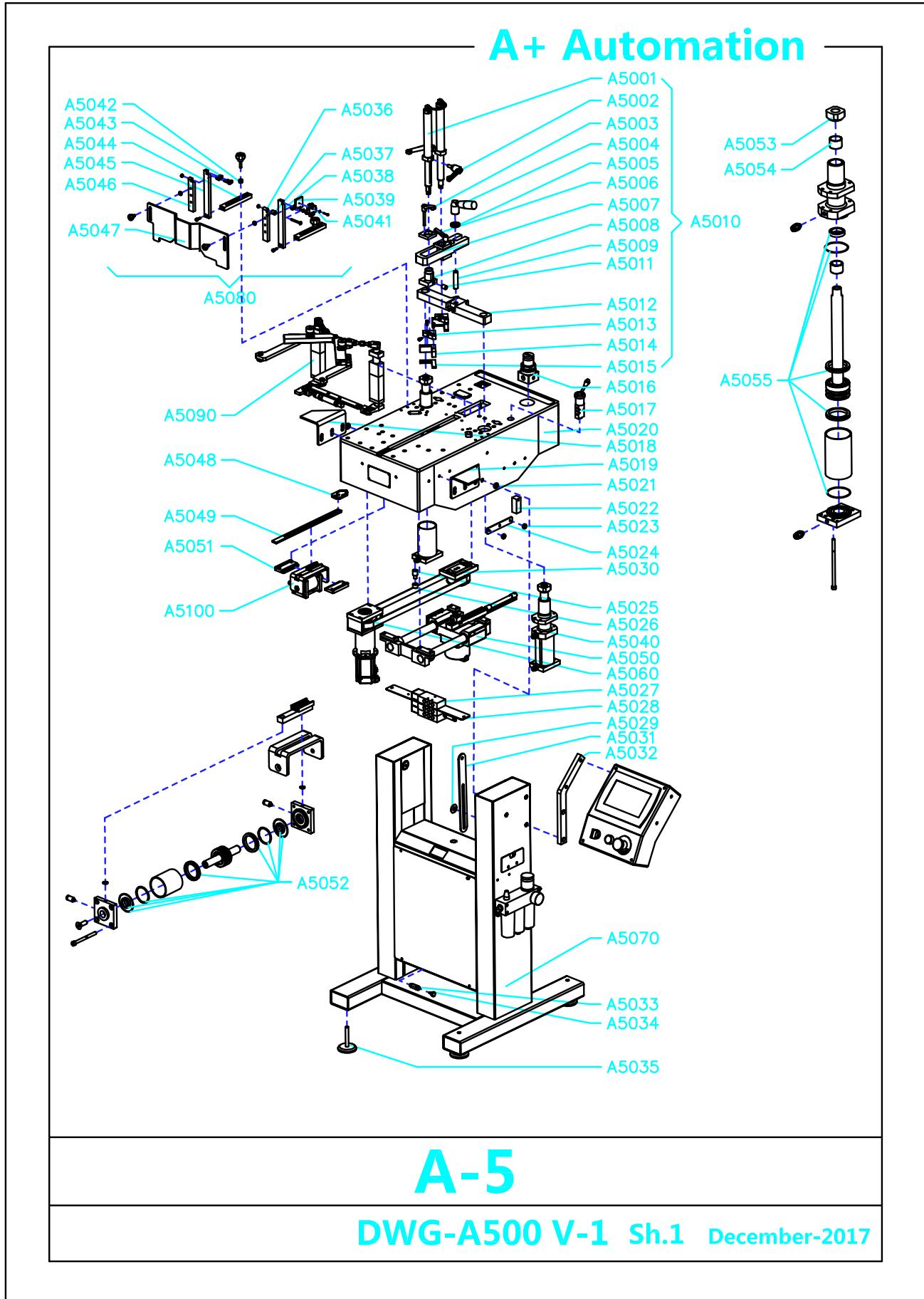

# A+ Automation

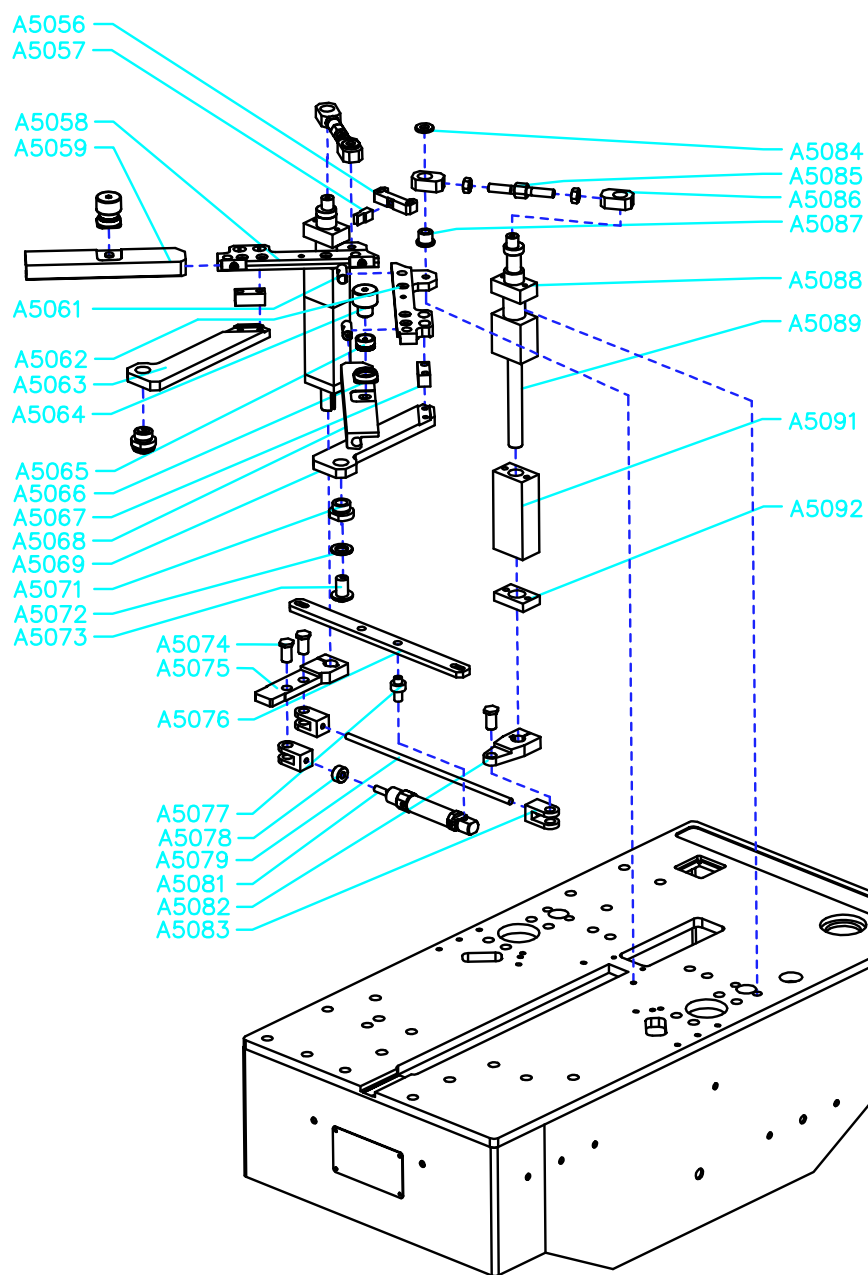

## A-5

DWG-A500 V-4 Sh.2 December-2017

# A+ Automation

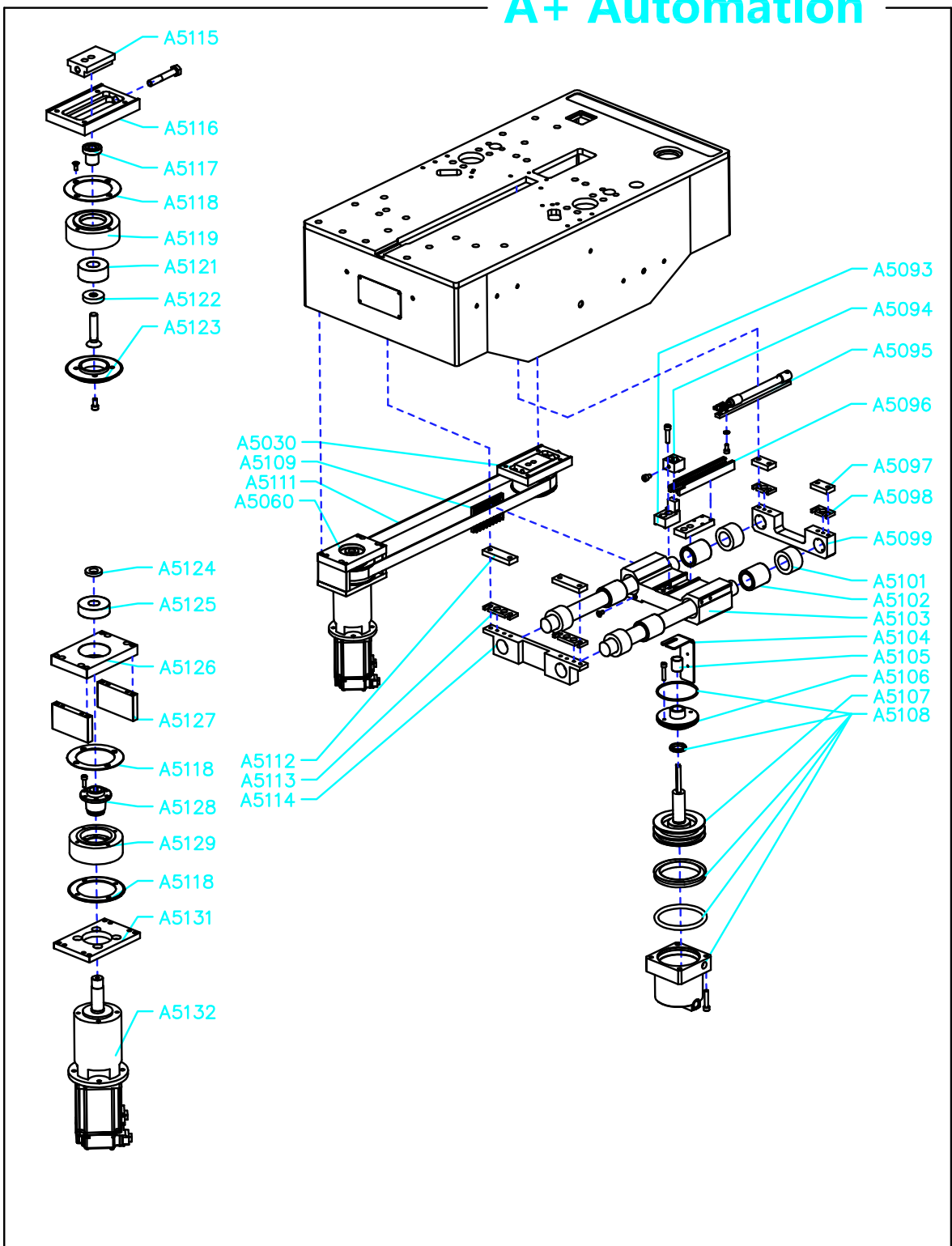

## A-5

DWG-A500 V-1 Sh.3 December-2017

**ATTACHMENT B - PNEUMATIC SCHEMATIC**

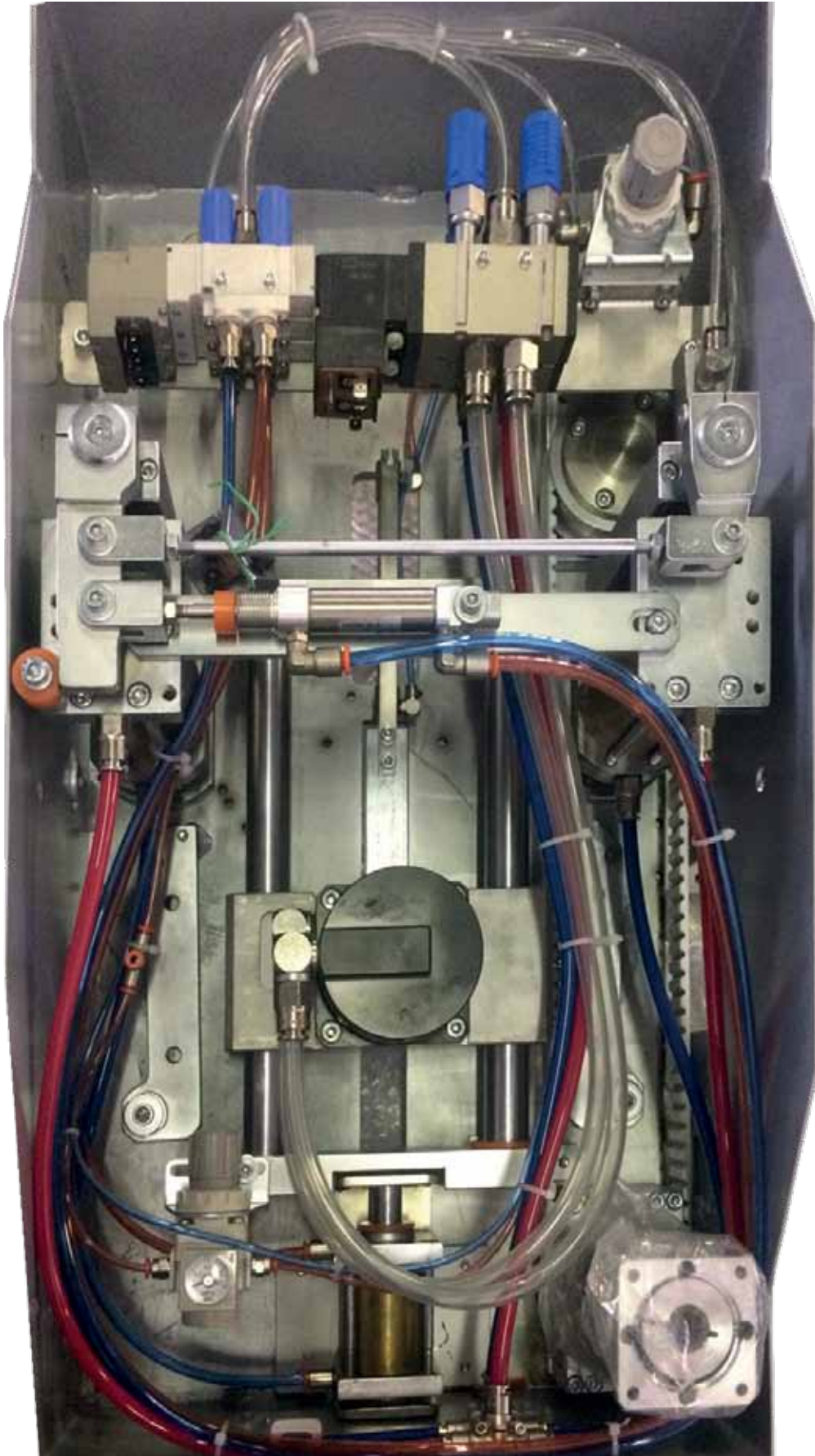

ATTACHMENT C - PLATES DISLOCATION



**A+AUTOMATION**  
Via Selva, 23/25 47122 Forlì, ITALY

Tipo / Type:	<b>A5-MemoTS</b>
Anno di costruzione / Year of construction:	<b>2018</b>
Matricola / Serial Number:	
Peso / Weight:	<b>130 Kg / 298 lbs</b>
Alimentazione pneumatica / Pneumatic feed:	<b>5-7 BAR / 70-100 PSI</b>
Alimentazione elettrica / Power supply:	<b>110-220V - 50-60 Hz</b>



## ATTACHMENT D - SHARPENING TABLE

Height mm	SOFT WOOD			HARD WOOD		
	Very soft wood	Soft wood	Averaged soft wood	Averaged hard wood	Hard wood	Very hard wood
<b>H 03' mm</b>	<>	<>	<>	MW	MW	MW
<b>H 05' mm</b>	MW	MW	MW	MW	MW	MW
<b>H 07 mm</b>	SW	SW	MW	MW	MW	HW
<b>H 10 mm</b>	SW	SW	MW	MW	HW	HW
<b>H 12 mm</b>	SW	SW	MW	HW	HW	HW
<b>H 15 mm</b>	SW	SW	MW	HW	HW	HW

\* Wedges available only on customer's request for orders higher than 500.000 pcs.

SW Suitable for soft wood such as: Cedar, Pine, Bass, Banak, Obeche, Poplar  
Other materials: Vertical Grain MDF

MW Suitable for soft wood such as: Cedar, Cherry, Oak, Ramin, Poplar, Maple, Pine  
Other materials: Vertical grain MDF, Polystyrene, PVC

HW Suitable for soft wood such as: Oak, Ash, Hickory, Pecan, Maple, Cherry, Ramin  
Other materials: Horizontal grain MDF



**In order to stack 2 or more Wedges per junction, use Wedges coded MW or HW.**

**ATTACHMENT E - ELECTRICAL SCHEMATIC  
CE Version**

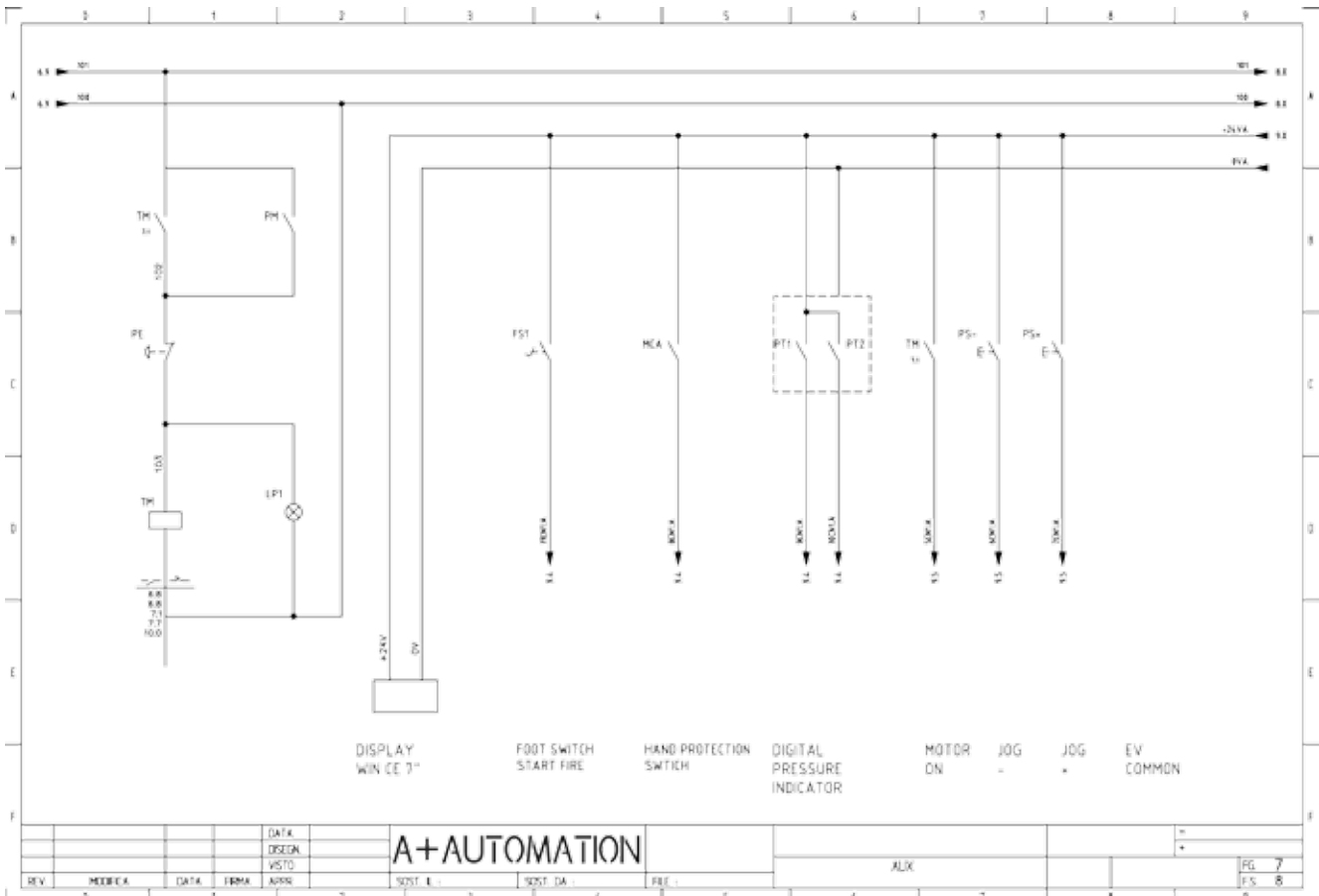
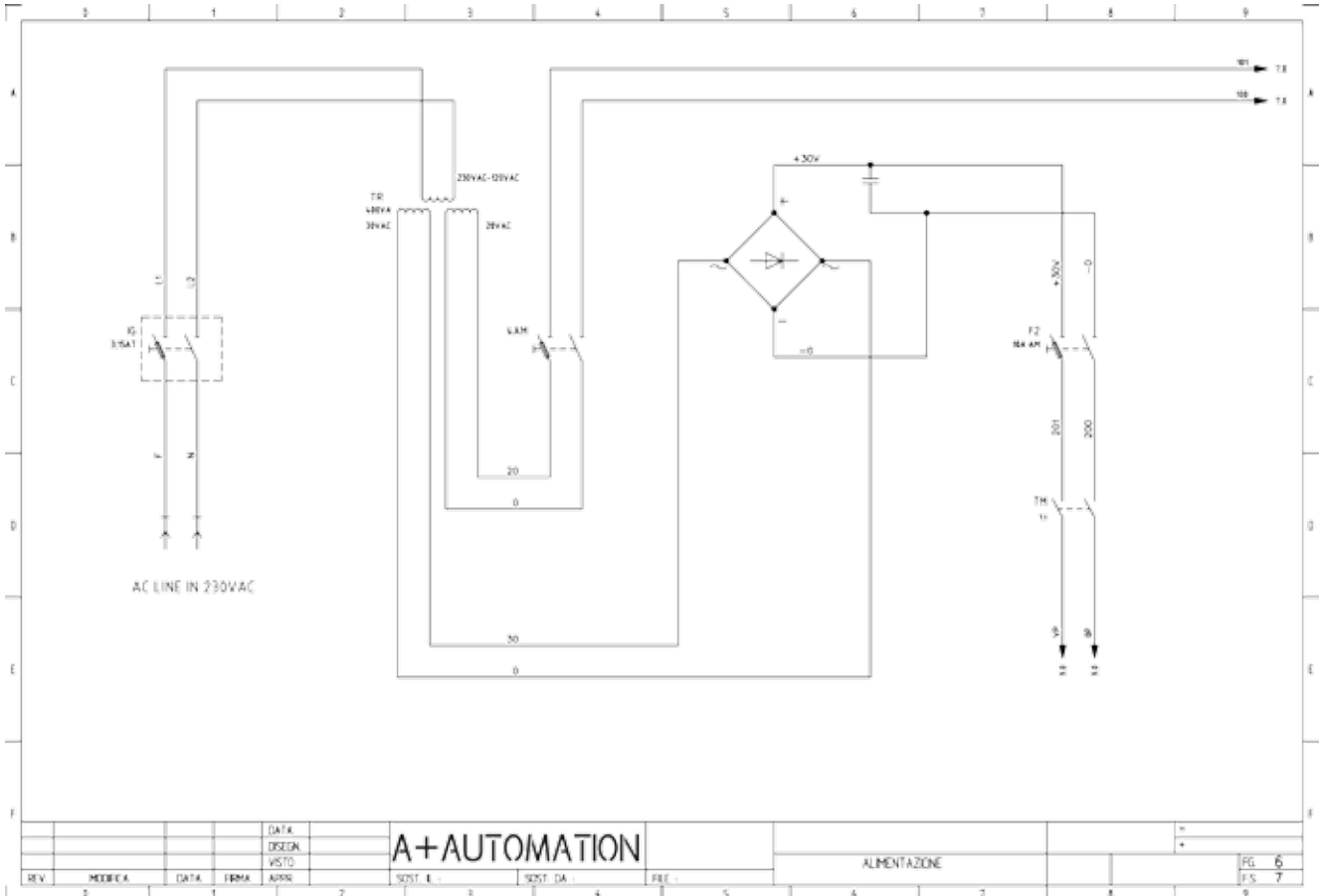



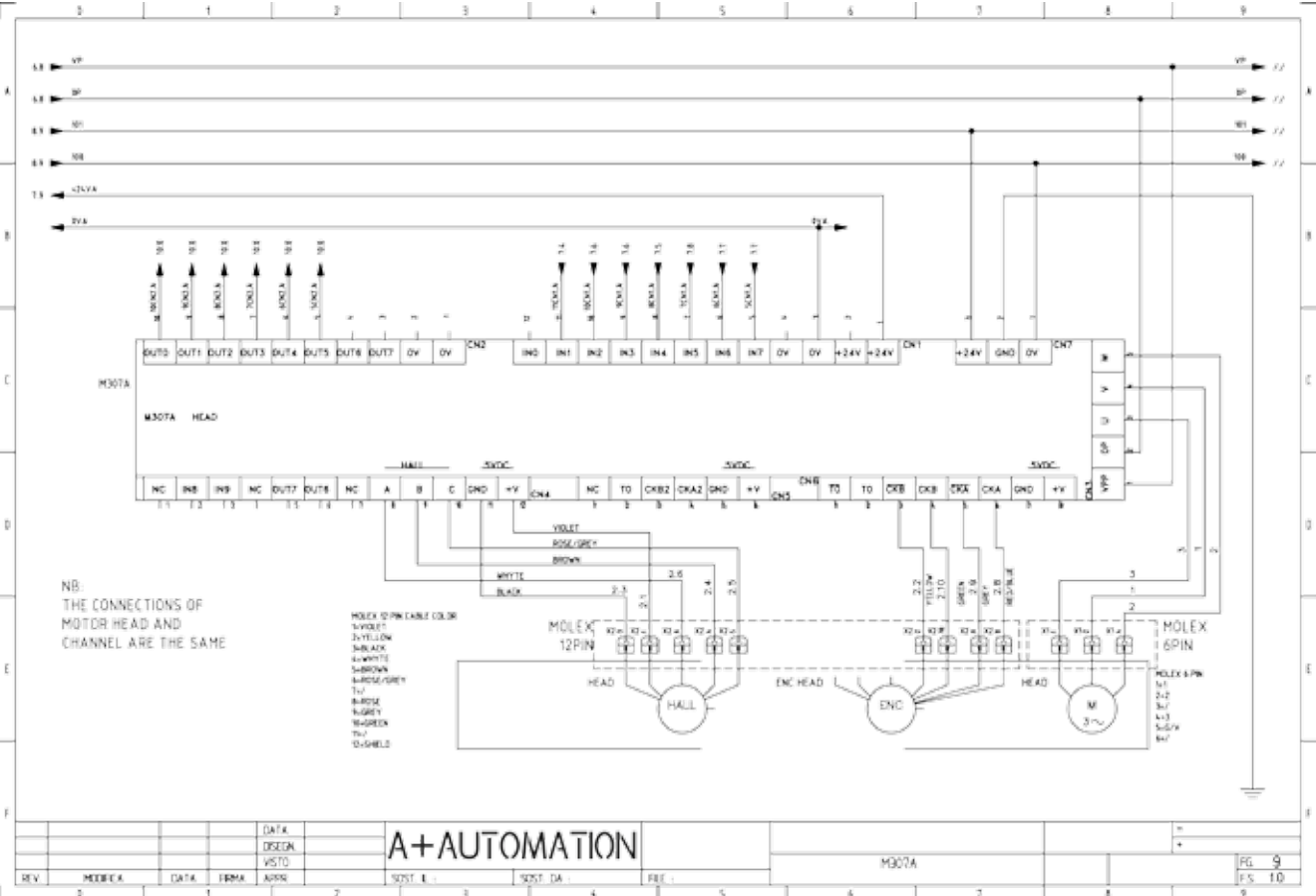
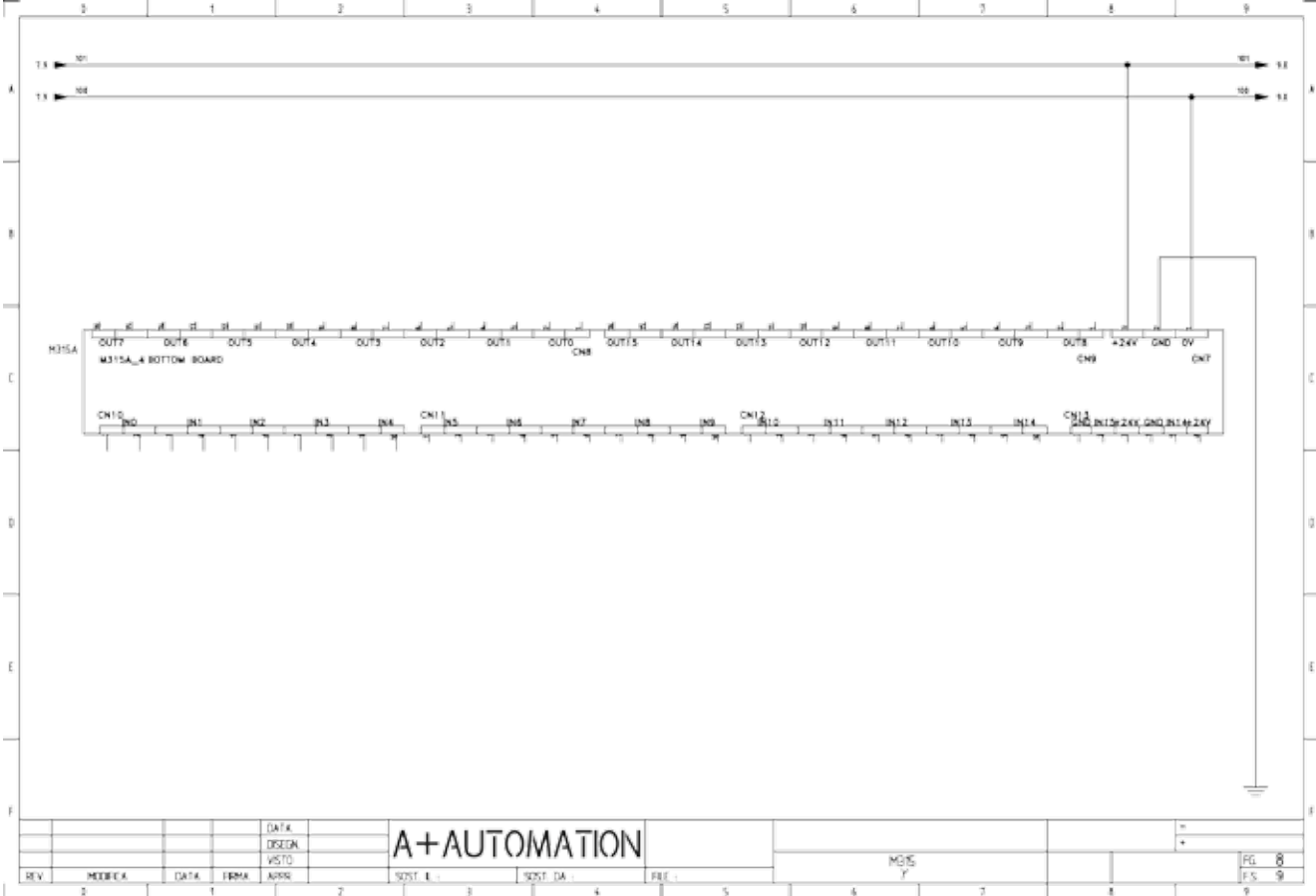

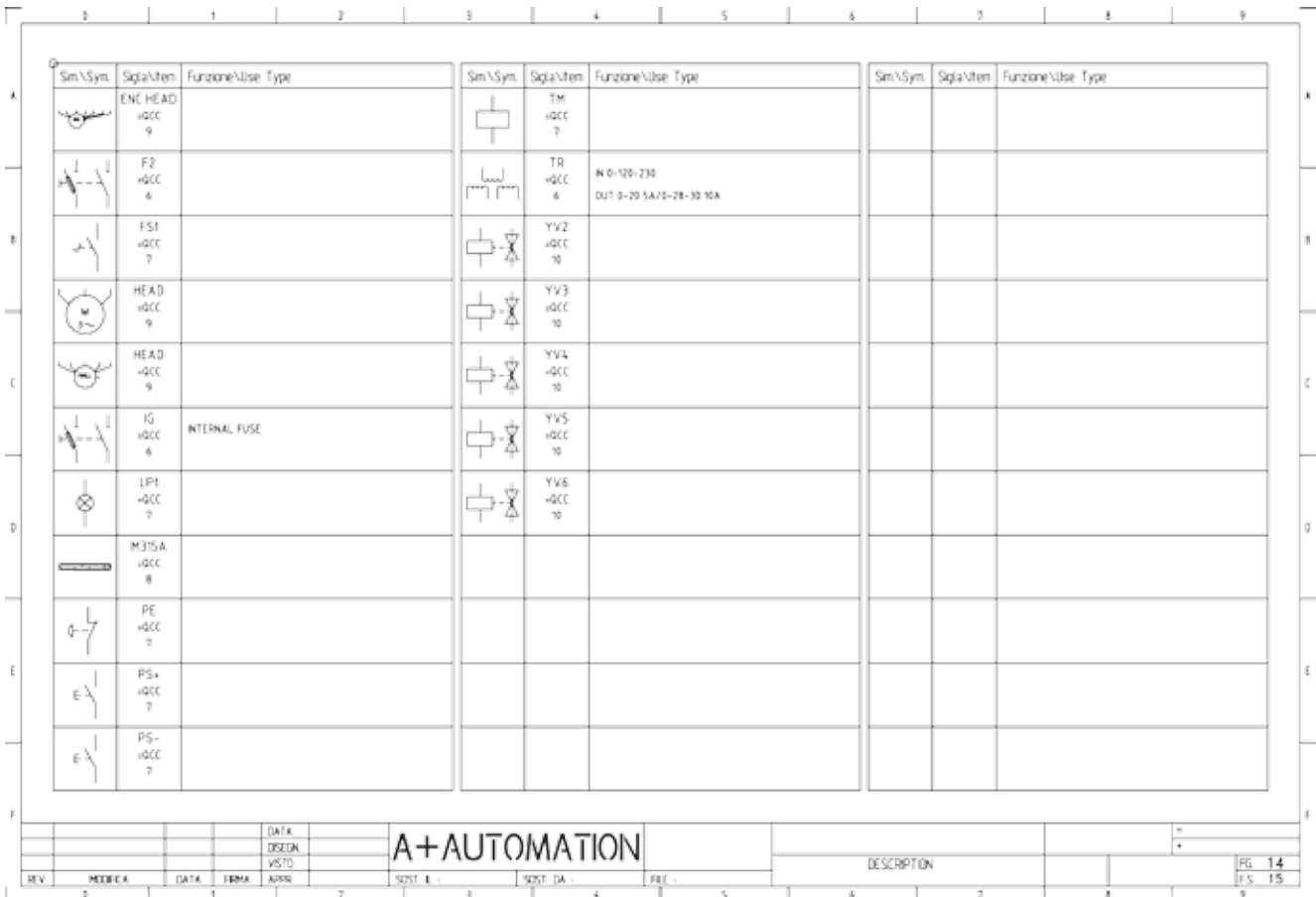
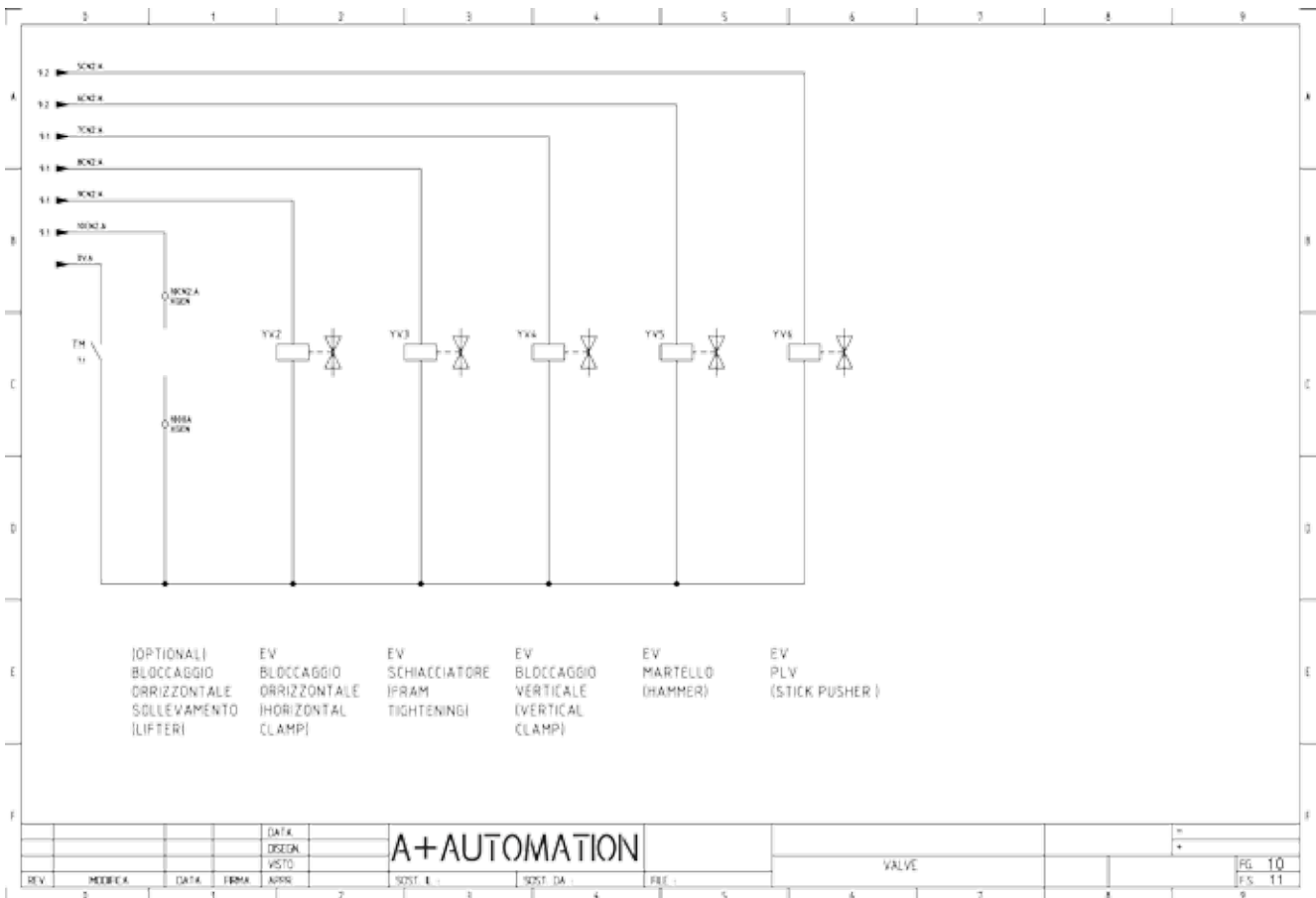



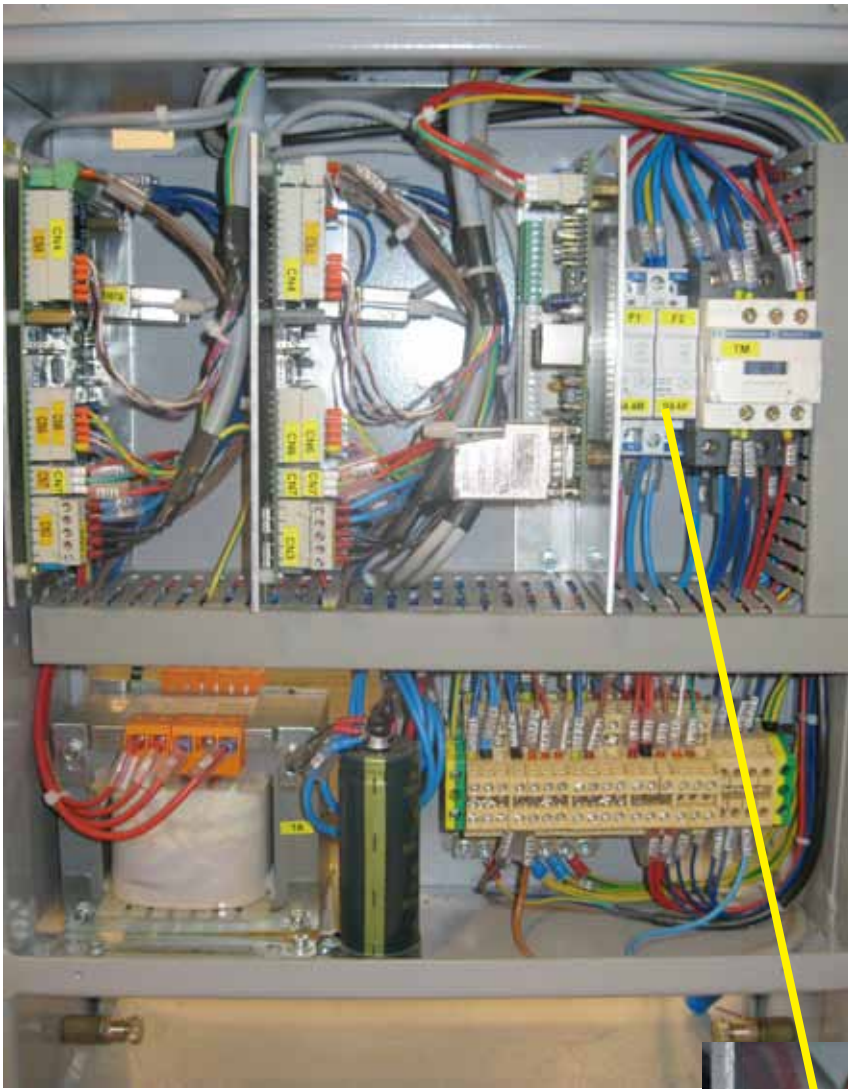



Fuse F1: 4 A 250 V delayed (type 5x20)

Fuse F2: 10 A 250 V delayed (type 5x20)

The main A switch located in the floor stand front mid side, contains a fuse support.

Machines can be equipped with two different main switches:

- Single fuse version;
- Double fuse version.

	<p><b>Use only fuses:</b></p> <p><b>250V 5ST 4A (5x20)</b></p>
---	--

To install / replace the fuse, proceed as follows:

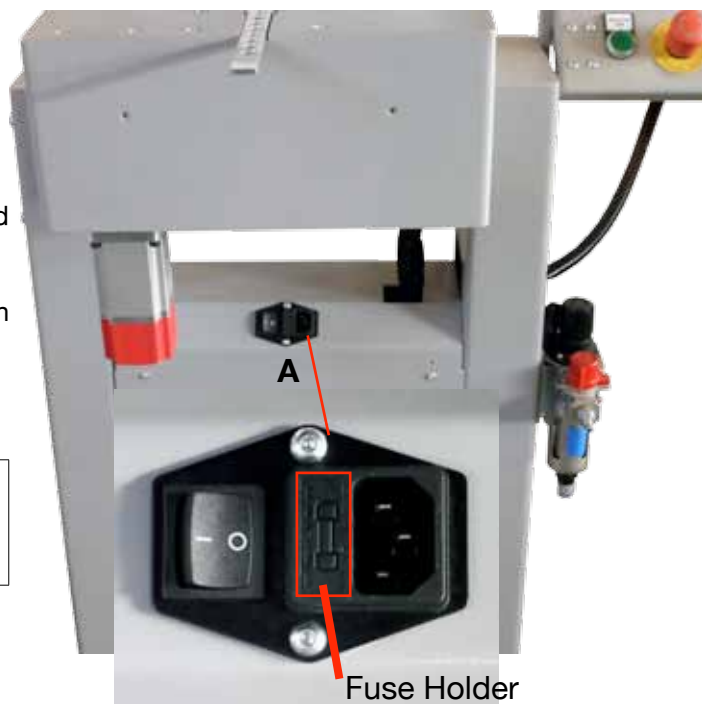

**Single fuse version:**

Using a screwdriver, lift up and extract the fuse holder:



Install / replace the fuse

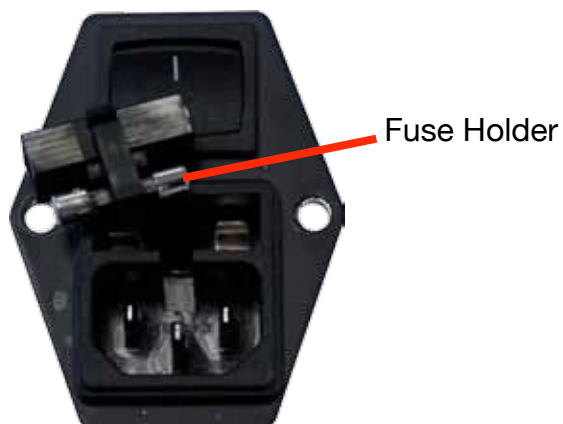

**Double fuse version:**

Using a screwdriver, lift up and extract the fuse holder:



Install / replace the fuses

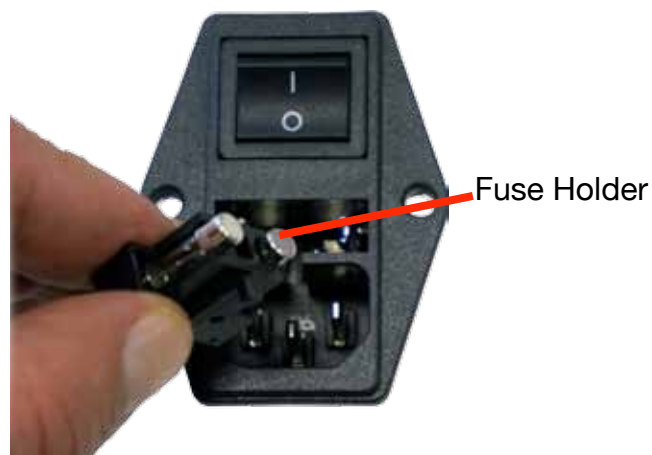

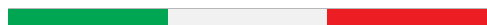
**A+AUTOMATION**

Via Selva, 23/25 - 47122 Forlì - Italy  
 Tel. +39 0543 481142 / Fax. +39 0543 480770  
 info@a-plusautomation.com / www.a-plusautomation.com

**DICHIARAZIONE CE DI CONFORMITÀ**

2006/42/CE (Allegato II parte A)

**Il sottoscritto, rappresentante il seguente fabbricante**

<i>Costruttore</i>	<b>A-Plus Automation S.r.l.</b>
<i>Indirizzo</i>	<b>Via Selva, 23/25, 47122 Forlì (FC) Italia</b>

ha incaricato la seguente persona autorizzata a costituire e conservare il fascicolo tecnico

<i>Nome</i>	<b>A-Plus Automation S.r.l.</b>
<i>Indirizzo</i>	<b>Via Selva, 23/25, 47122 Forlì (FC) Italia</b>

**Il fabbricante dichiara qui di seguito che la macchina**

<i>Denominazione generica / commerciale</i>	<b>A5-MemoTS</b>
<i>Funzione</i>	<b>Assemblatrice elettronica per cornici e telai</b>
<i>Modello</i>	<b>A5</b>
<i>Tipo</i>	<b>A5-MemoTS</b>
<i>Matricola</i>	<b>A5.18.xxxx</b>
<i>Anno di costruzione</i>	<b>2018</b>

risulta in conformità a tutte le disposizioni pertinenti previste dalle seguenti direttive comunitarie (comprese tutte le modifiche applicabili)

<b>2006/42/CE - Direttiva Macchine</b>
--

<b>2004/108/CE - Direttiva Compatibilità Elettromagnetica</b>
---

*L'elenco delle principali norme seguite per la parte applicabile e secondo quanto documentato nel fascicolo tecnico, è allegato alla presente dichiarazione.*

Forlì, 02/01/2018.

L'amministratore, Dennis Zavoli

**- LINGUA ORIGINALE -**

A-Plus Automation s.r.l.  
 C.F. e P.IVA IT 04349600405 – REA: FO-404194

**A+AUTOMATION**Via Selva, 23/25 - 47122 Forlì - Italy  
Tel. +39 0543 481142 / Fax. +39 0543 480770  
info@a-plusautomation.com / www.a-plusautomation.com**CE DECLARATION OF CONFORMITY**

2006/42/CE (ATTACHED II part A)

**The undersigned, representing the following manufacturer**

<i>Manufacturer</i>	<b>A-Plus Automation S.r.l.</b>
<i>Address</i>	<b>Via Selva, 23/25, 47122 Forlì (FC) Italia</b>

**has instructed the person authorized to compile and retain the technical file**

<i>Name</i>	<b>A-Plus Automation S.r.l.</b>
<i>Address</i>	<b>Via Selva, 23/25, 47122 Forlì (FC) Italia</b>

**The manufacturer declares that the under mentioned machine**

<i>Generic / Trade name</i>	<b>A5-MemoTS</b>
<i>Funzione</i>	<b>Electronic frame assembling machine</b>
<i>Model</i>	<b>A5</b>
<i>Type</i>	<b>A5-MemoTS</b>
<i>Serial Number</i>	<b>A5.18.xxxx</b>
<i>Year of manufacture</i>	<b>2018</b>

**conforms with all provision applicable under the following EU Directives  
(including all applicable modifications)**

<b>2006/42/CE - Machine Directive</b>
---------------------------------------

<b>2004/108/CE - Electromagnetic Compatibility Directive</b>
--

*The list of main standards followed by the applicable part and as documented in the technical file, is attached to this statement.*

Forlì, 02/01/2018.

The managing director, Dennis Zavoli

**- TRADUZIONE -**A-Plus Automation s.r.l.  
C.F. e P.IVA IT 04349600405 – REA: FO-404194

A-Plus Automation s.r.l.  
Via Selva, 23/25  
47122 - Forlì (FC) Italy

Phone +39 0543 481142  
Fax +39 0543 480770  
Email [info@a-plusautomation.com](mailto:info@a-plusautomation.com)  
Web [www.a-plusautomation.com](http://www.a-plusautomation.com)

**A+AUTOMATION**

